

markmaker®

Traditional stamps and
an extensive line of
signage and print products



Expanded
Product
Catalogue

Now offering the full
Trodat product line



GET CREATIVE WITH **markmaker**®



NEW CUSTOM SIZE SIGNS (PG 35)



NEW TABLE TOP SIGNS (PG 51)



NEW BANNER FLAGS (PG 50)



NEW NAMEPLATES (PG 34)



NEW BANNERS AND STANDS (PG 47)



NEW BUSINESS CARDS (PG 26)



NEW NAME BADGES (PG 32)

TERMS AND CONDITIONS

SHIPPING: Freight is extra and will be added to invoices. We will ship as specified on your order or by best way. On request, or when required, we will ship collect or COD. A handling charge will be applied on a per shipment basis. Drop shipping is available but charged at standard shipping rates. Claims for shortages must be presented within 15 days of receipt of goods to be considered.



PRICES: All current prices in this catalogue are subject to change without notice. We reserve the right to invoice all merchandise at prices in effect at the time of shipment. Prices exclude all taxes. All prices are FOB from our plants. Terms of payment are as stated on our invoice. Interest will be charged on overdue accounts as per invoice.



GUARANTEED QUALITY: All goods furnished here are warranted to be within our quality standards for such goods. Our liability, in any event, is limited to your net purchase of such goods or, at our option, to the replacement of such goods upon their return to us - transportation charges prepaid.



LIFETIME GUARANTEE: Our custom ProStamp, PS Upright Stamp, Xstamper® stamp, and Mark Maker® Embosser, are guaranteed against defects in workmanship and materials for as long as you own them, under normal usage, proper care, and proper re-inking. The stamps must be re-inked with our re-inking ink of the same colour and stamp type. Should something occur, we will repair or replace the defective stamp or embosser with the same size, style, impression, and colour of the original defective model. The product must be returned where purchased.



RETURNS AND ALLOWANCES: Merchandise shipped in error or found to be defective may be returned for full credit. No merchandise will be accepted for return later than 15 days after shipment without prior authorization. Merchandise other than made-to-order products, returned for any reason other than error, may be accepted (upon approval) for credit less a 20% restocking charge. Orders cancelled during production will be charged for the work completed at the time of cancellation including proofs.



DIGITAL ARTWORK: Files under 10MB, email to: orders@sterling.ca. Files up to 20GB, upload online at: wetransfer.com. Please supply art as black and white or CMYK colour profile PDF. Vector art (PDF, AI, EPS, CDR) is always preferred. Also accept PSD, BMP, TIFF, and JPG files. Resolution of art images should be 300 dpi at 100% print size. Fonts must be supplied or converted to curves. Signatures must be supplied as a black and white scanned image on plain white unlined paper. If colour matching is critical, please provide us with specific CMYK colours. Additional colour matching charges may apply and colour matching cannot be guaranteed. Hourly charges apply to any adjustments needed to your artwork once received.

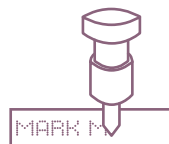

STAMPS

Professional Self-Inking4-5
 Self-Inking Eco Stamps 6
 Self-Inking Trodat Stamps7
 XStamper Pre-Inked8-9
 Prostamp Pre-Inked10
 PS Flash11
 Classic Rubber Stamps 12-13
 Specialty Stamps14-15
 Inspector Stamps 16
 Industrial Stamps 17

DATERS & NUMBERERS

Die Plate Daters 18
 Self Ink Daters19
 Stock Daters 20
 Versa Dater21
 Stock Numberers22
 Electric Embossers and Time Stamps23

EMBOSSERS & LEGAL SEALS

Switch Emboss 24
 Legal & Notary Seals 25

PRINTING

Business Cards 26-27
 Posters, Envelopes, Letterhead, Postcards, Brochures 28-29

NAMEPLATES & BADGES

Engraved Name Badges 30
 Engraved Nameplates 31
 Full Colour Name Badges & Identification 32-33
 Full Colour Nameplates 34

SIGNAGE

Custom Size Signs 35
 Full Colour Vinyl 36-37
 Vinyl Custom Sizes 38-39
 Kiss Cut Vinyl Decals & Floor Decals 40-41
 Full Colour Signage 42-43
 Styrene Plastic Posters 44
 Vehicle Wraps & Magnetic Signage 45
 Coroplast/Lawn Signs 46
 Retractable Banner Stands 47
 Full Colour Banners 48-49
 Feather & Teardrop Flags 50
 Table Top Signs & Hanging Banners 51
 Trophies, 3D Lettering, and Plaques 52
 Custom Dry Erase Boards 53
 Stencils & Aluminum Signage 54

INDUSTRIAL

Price Guns 55

STAMPS

DATERS

EMBOSSERS

PRINTING

NAMEPLATES

SIGNAGE

INDUSTRIAL



PROFESSIONAL SELF-INKING

Stronger. Cleaner. Faster. Our toughest line yet!

- Heavy Duty Self-inking stamp made with brushed stainless steel
- Comes with built-in ink pad - no mess & easy to replace
- Sturdy base for smooth quality imprints
- Up to 5000 impressions

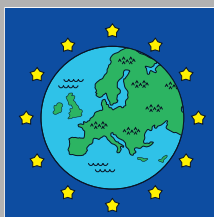

Made in Europe, our stamps and inks are of the highest quality - guaranteed



High-quality brushed stainless steel for maximum stability and durability



Non-toxic water based ink pads are fast & mess-free to change - date setting too



Manufacturer certified Climate-Neutral is standard on all PRO HD stamps

5200 \$76.95



15/16 x 1-9/16" 24 x 40 mm
max. 6 lines
ink pad: 6/50 \$11.35

5203 \$89.95



1-1/8 x 1-7/8" 28 x 48 mm
max. 7 lines
ink pad: 6/53 \$11.35

5208 \$146.95

YOUR ACCOUNT IS NOW PAST DUE



AMOUNT OWING: \$ _____

Please pay the full amount to avoid penalties

1-3/4 x 2-9/16" 44 x 65 mm
max. 11 lines
ink pad: 6/58 \$18.35

NEW



NEW

5212 \$235.95

2-11/16 x 4-9/16" 69 x 116 mm
max. 18 lines
ink pad: 6/512 \$21.95

5211 \$161.95

2-3/16 x 3-3/8" 55 x 85 mm
max. 14 lines
ink pad: 6/511 \$19.95

5206 \$105.95

PROOF



APPROVED

1-5/16 x 2-3/16" 33 x 56 mm
max. 9 lines
ink pad: 6/56 \$15.65

52045 \$123.95

1-3/4" 45 mm dia
max. 10 lines
ink pad: 6/15 \$15.65



Professional - Daters and Stock Daters

Our Professional Daters are made for work and come with a min. 8 years of date bands. Can be customized with text or logos. We also offer stock titles or date only options. Date height is 4 mm.



2 colour pads are **BLUE** with **RED** middle. Part # has "1/2" on the end.

PROFESSIONAL

54110 \$165.95

NEW

SMART MONEY BANK

CUSTOMER NAME

CUSTOMER #	DEC 14 2030	TAX #
ADDRESS		
SIGNATURE		

2-3/16 x 3-3/8" 55 x 85 mm
max. 15 lines
ink pad: 6/511 \$19.95
ink pad: 6/511/2 \$21.95

5480 \$149.95

YOUR ACCOUNT IS NOW PAST DUE
IF PAYMENT IS RECEIVED BY:

DEC 14 2030

YOUR COMPANY WILL AVOID ALL SERVICE CHARGES

1-3/4 x 2-9/16" 44 x 65 mm
max. 11 lines
ink pad: 6/58 \$18.35
ink pad: 6/58/2 \$19.65



54045 \$146.95

NEW

FROZEN BERRY CO.

DEC 14 2030

PACKAGED DATE
CONTROL ID NO.
5195785

1-3/4" 45 mm dia
max. 10 lines
ink pad: 6/15 \$15.65
ink pad: 6/15/2 \$18.35

5430 \$119.95

DELIVERED ON

DEC 14 2030

BY: _____

15/16 x 1-9/16" 24 x 40 mm
max. 6 lines
ink pad: 6/50 \$11.35
ink pad: 6/50/2 \$14.65

5440 \$123.95

-SCANNED-

DEC 14 2030

Art Department

1-1/8 x 1-7/8" 28 x 48 mm
max. 7 lines
ink pad: 6/53 \$11.35
ink pad: 6/53/2 \$15.65

5460 \$136.95

PAID

DEC 14 2030

BY: _____

1-5/16 x 2-3/16" 33 x 56 mm
max. 9 lines
ink pad: 6/56 \$15.65
ink pad: 6/56/2 \$18.35

5030 \$87.95

DEC 14 2030

4 mm date height
ink pad: 6/50 \$11.35

5430-S2 \$82.95 **NEW**

PAID

DEC 14 2030

15/16 x 1-9/16" 24 x 40 mm
5/32" 4 mm date height
ink pad: 6/50/2 \$14.65

Choose from 6 other stock titles (shown smaller). Also available in French.

5430-S3 E-MAILED DEC 14 2030	5430-S9 FAXED DEC 14 2030	5430-S7 POSTED DEC 14 2030
RECEIVED DEC 14 2030	DRAFT DEC 14 2030	COPY DEC 14 2030
5430-S1	5430-S4	5430-S5

Professional - Numberers and Stock Numberers

Professional Numberers are made for work and can be customized with text or logos or come stock for numbers only. Ask to see additional band characters.



5558/PL \$165.95

JOB#

1 2 3 4 5 6 7 8

FLOWER POWER

1-1/4 x 2-3/16" 31 x 56 mm
8 Bands - 5 mm Number Height
ink pad: 6/56 \$15.65

55510/PL \$175.95

TECHNOKORP
22 Wonderland Rd.
Winnipeg, MB R2C 0P3

1 2 3 4 5 6 7 8 9 0

ACCOUNT NUMBER

1-1/4 x 2-3/16" 31 x 56 mm
10 Bands - 5 mm Number Height
ink pad: 6/56 \$15.65

5546 \$86.35

1 2 3 4 5 6

6 Bands - 4 mm high
ink pad: 6/50 \$11.35

5558 \$91.95

1 2 3 4 5 6 7 8

8 Bands - 5 mm Number Height
ink pad: 6/56 \$15.65

55510 \$125.95

1 2 3 4 5 6 7 8 9 0

10 Bands - 5 mm Number Height
ink pad: 6/56 \$15.65

55512 \$135.95

NEW

1 2 3 4 5 6 7 8 9 0 1 2

12 Bands - 5 mm Number Height
ink pad: 6/58 \$18.35



SELF-INKING ECO STAMPS

Our most popular stamps, our most popular 5 sizes!

- Made in Europe with up to 65% recycled content
- Comes with built-in ink pad - no mess & easy to replace
- Best for medium repetition on bond paper
- Up to 5000 impressions



Made in Europe, our stamps and inks are of the highest quality - guaranteed

Easy to use lock located on the back of the stamp - just slide to lock

Non-toxic water based ink pads are fast & mess-free to change

Our self-inking line is made with recycled plastic content

ECO0.5 \$39.35

MADE BY
Kiara Z.

1/4" x 1-1/16" 9 x 25 mm
max. 2 lines
ink pad: 6/4910 \$11.35

ECO1 \$42.95



1/2" x 1-7/16" 13 x 38 mm
max. 3 lines
ink pad: 6/4911 \$11.35

ECO2 \$46.95

**ANIMAL AID
RESCUE DIVISION**

3/4" x 1-13/16" 17 x 46 mm
max. 5 lines
ink pad: 6/4912 \$12.35

ECO3 \$54.35

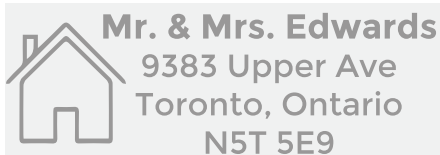

13/16" x 2-1/4" 21 x 58 mm
max. 6 lines
ink pad: 6/4913 \$13.65

ECO3.5 \$55.35



1-1/8" x 2-5/8" 24 x 69 mm
max. 7 lines
ink pad: 6/4915 \$14.65

SELF-INKING TRODAT™ STAMPS

Same great features as the ECO stamps!

- Made in Europe with up to 65% recycled content
- Comes with built-in ink pad - no mess & easy to replace
- Best for medium repetition on bond paper
- Up to 5000 impressions



Self-Inking TRODAT

4912 \$48.95



3/4" x 1-13/16" 17 x 46 mm
max. 5 lines
ink pad: 6/4912 \$12.35

4913 \$56.35



13/16" x 2-1/4" 21 x 58 mm
max. 6 lines
ink pad: 6/4913 \$13.65

4915 \$57.35



1-1/8" x 2-5/8" 24 x 69 mm
max. 7 lines
ink pad: 6/4915 \$14.65

4926 \$66.35

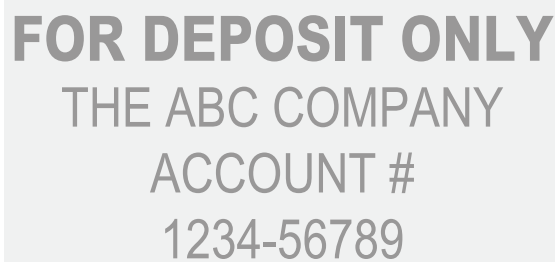

1-7/16" x 2-15/16" 37 x 74 mm
max. 9 lines
ink pad: 6/4926 \$16.95

4911 \$44.95

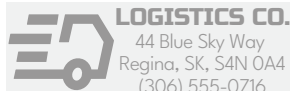

1/2" x 1-7/16" 13 x 38 mm
max. 3 lines
ink pad: 6/4911 \$11.35

4916 \$45.65



3/8" x 2-11/16" 9 x 69 mm
max. 3 lines
ink pad: 6/4916 \$11.35

4925 \$62.95



15/16" x 3-3/16" 24 x 81 mm
max. 6 lines
ink pad: 6/4925 \$15.95

4910 \$41.35

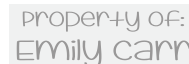

1/4" x 1-1/16" 9 x 25 mm
max. 2 lines
ink pad: 6/4910 \$11.35

4612 \$34.95



7/16" 11 mm dia.
max. 2 lines
ink pad: 6/4612 \$12.35

46019 \$37.35



11/16" 18 mm dia.
max. 3 lines
ink pad: 6/46019 \$12.35

4630 \$57.95



1-3/16" 30 mm dia.
max. 6 lines
ink pad: 6/4630 \$12.35

4642 \$67.95



1-5/8" 41 mm dia.
max. 7 lines
ink pad: 6/4642 \$14.35

46050 \$77.35



1-7/8" 48 mm dia.
max. 9 lines
ink pad: 6/46050 \$14.35

4924 \$67.65



1-9/16" x 1-9/16" 39 x 39 mm
max. 10 lines
ink pad: 6/4924 \$13.65

4923 \$54.95



1-1/8" x 1-1/8" 29 x 29 mm
max. 7 lines
ink pad: 6/4923 \$12.35

4922 \$37.65



3/4" x 3/4" 19 x 19 mm
max. 5 lines
ink pad: 6/4922 \$12.35

4921 \$34.65



7/16" x 7/16" 11 x 11 mm
max. 5 lines
ink pad: 6/4921 \$12.35



XSTAMPER PRE-INKED

Extremely durable with superior quality for all uses.

- Pre-inked, no stamp pad required
- Re-inkable up to 50,000 impressions before re-inking
- Lifetime guarantee

XStamper Refill Ink



N100-10	10ml	\$11.95
N100-20	20ml	\$17.35
N100-60	60ml	\$37.95



Made with 100% recycled plastic. Components are up to 65% recycled. Re-ink stamp after 50,000 impressions.

N04 \$37.95

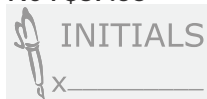

1/2" x 1-1/16" 13 x 27 mm
max. 3 lines

N13 \$51.95

J. B. Thompson
321 Main St. East
Windsor, ON N8X 3G3

9/16" x 2" 14 x 51 mm
max. 3 lines

N10 \$50.35

From the desk of
SHALIMAR MARIE

1/2" x 1-5/8" 13 x 41 mm
max. 3 lines

N12 \$56.65



1" x 2" 25 x 51 mm
max. 7 lines

N11 \$51.95

Studio East Health Club
1111 William Morgan Dr.
Toronto, ON
M4H 3E9

11/16" x 1-15/16" 17 x 49 mm
max. 4 lines

N14 \$56.65

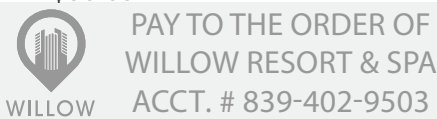

5/8" x 2-7/16" 16 x 62 mm
max. 4 lines

N18 \$62.35

**CERTIFIED TRUE COPY
OF AN ORIGINAL DOCUMENT**
SIGNED _____
DATE _____

7/8" x 2-3/4" 22 x 70 mm
max. 6 lines

N20 \$64.65 TWO COLOUR*



ALLIANCE LAW

7/8" x 2-3/4" 22 x 70 mm
max. 5 lines

**CONFIDENTIAL
INTERNAL
USE ONLY**

*Colours can split in half vertically or horizontally and are separated by 1/8"

N05 \$35.95

YOUR INITIALS HERE PLEASE _____

1/8" x 2-3/8" 3 x 60 mm
max. 1 line

N36 \$32.95

Signature Here

3/16" x 1-1/8" 5 x 36 mm
max. 1 line

N37 \$32.95

Account #12345-990-1

3/16" x 1-9/16" 5 x 40 mm
max. 1 line



Pocket Stamps Ideal for Commissioners and Notary stamps.

N40 \$38.35

John Johnson, City of St. Thomas
Notary Public, Commission No. 12345
My Commission Expires 10/31/2011

1/2" x 2" 13 x 51 mm
max. 3 lines

N42 \$51.95

Thomas Lawrence Bogart
Commissioner of Deeds, County of Elgin
No. 4-0000 Cert. Filed in Elgin County
Commission Expires 3-1-2024

5/8" x 2-7/16" 16 x 62 mm
max. 4 lines

N26 \$64.95



11/16" x 3-5/16" 17 x 84 mm
max. 4 lines

N24 \$81.35



1-3/16" x 3-1/8" 30 x 79 mm
max. 8 lines

N27 \$102.95

VERIFICATION OF RECEIPT DATE

Received by: _____

Account #: _____

Carrier: _____

Dock #: _____

Customs I.D.: _____

TIMELINESS	CONDITION
<input type="radio"/> ON TIME	<input type="radio"/> PERFECT
<input type="radio"/> LATE	<input type="radio"/> DAMAGED
<input type="radio"/> EARLY	<input type="radio"/> INCOMPLETE
<input type="radio"/> RETURNED	<input type="radio"/> AS EXPECTED
	<input type="radio"/> PENDING

1-9/16" x 3-15/16" 40 x 100 mm
max. 10 lines

N16 \$68.35

Southern Retail Store
349 Mountain Road
San Diego, CA 90210
TEL: (619) 555-2211
FAX: (619) 555-2214
EMAIL: info@southern.com
www.southernretail.com



1-1/2" x 2-1/2" 38 x 64 mm
max. 10 lines

N22 \$94.35

DATE:
NAME:
ADDRESS:
CITY:
PROV/ STATE:
POSTAL /ZIP:
TEL:
FAX:
E MAIL:

2" x 2-15/16" 51 x 75 mm
max. 13 lines

N28 \$116.95

VALID PURCHASE ORDER RECEIVED

I CERTIFY THAT THE
ARTICLES AND/OR SERVICES
HAVE BEEN RECEIVED AND
INSPECTED AND
ACCEPTED EXCEPT AS
OTHERWISE NOTED.

TELLALL CORPORATION

2-9/16" x 3-15/16" 65 x 100 mm
max. 17 lines



N51 \$47.35



15/16" 24 mm diameter
max. 4 lines

N49 \$51.95



1-3/16" 30 mm diameter
max. 5 lines

N53 \$67.65

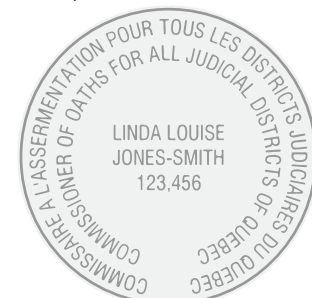

1-9/16" 40 mm diameter
max. 7 lines



PROSTAMP PRE-INKED

Turn signatures, logos, text, photos into a stamp!

- Pre-inked, no stamp pad required
- 50,000 impressions before re-inking
- Very detailed impression quality & a lifetime guarantee



Turn your face into a stamp!

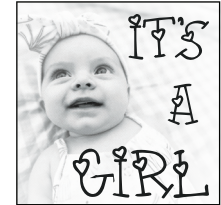

B1438 \$48.65



7/16 x 1-3/8" 12 x 36 mm
max. 3 lines

B1060 \$44.35



5/16 x 2-1/4" 8 x 57 mm
max. 2 lines

B1212 \$34.35



3/8 x 3/8" 10 x 10 mm
max. 2 lines

B2260 \$64.35



3/4 x 2-1/4" 19 x 56 mm
max. 5 lines

B1850 \$51.95



5/8 x 1-7/8" 16 x 47 mm
max. 4 lines

B2020 \$39.65



11/16 x 11/16" 18 x 18 mm
max. 4 lines

B3458 \$73.65

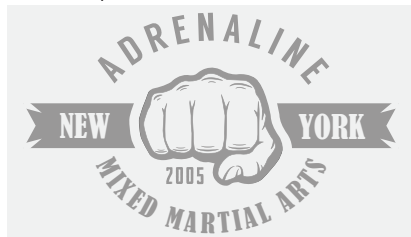

1-1/4 x 2-1/8" 31 x 54 mm
max. 7 lines

B2770 \$72.35



15/16 x 2-5/8" 24 x 66 mm
max. 6 lines

B3030 \$52.95

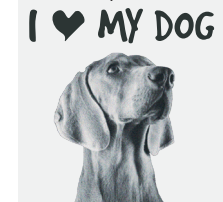

1-1/16 x 1-1/16" 27 x 27 mm
max. 6 lines

ProStamp Refill Ink



0.67 fl.oz
20 ml

BINK1	Black	\$20.95
BINK2	Red	\$20.95
BINK3	Blue	\$20.95



B4090 \$92.35



1-7/16 x 3-3/8" 37 x 85 mm
max. 9 lines



PS FLASH PRE-INKED STAMPS

A custom FLASH stamp for high repetition on bond paper.

- Brand new process is cleaner to produce yet capable of the finest lines!
- Pre-inked, no stamp pad required
- Fast and Easy re-inking for 1000's of impressions
Huge impression sizes available - great for branding!



Note: Most PS FLASH sizes are the same as Classic Rubber stamp sizes and can be viewed on pages 12-13. Larger sizes are not shown but are available below.

Mount Style



Part #	Size (in)	Size (mm)	Max Lines	Price
PS9	5/8 x 2-1/2"	16 x 64 mm	4	\$48.35
PS13	5/8 x 3-5/8"	16 x 92 mm	4	\$50.95
PS15	5/8 x 1-5/8"	16 x 41 mm	4	\$47.35
PS17	7/8 x 2-1/4"	22 x 57 mm	6	\$54.35
PS19	7/8 x 2-7/8"	22 x 73 mm	6	\$56.35
PS21	1-1/8 x 1-7/8"	29 x 48 mm	7	\$56.35
PS23	1-1/8 x 2-7/8"	29 x 73 mm	7	\$59.95
PS27	1-5/8 x 2"	41 x 51 mm	10	\$61.95
PS29	1-5/8 x 2-7/8"	41 x 73 mm	10	\$65.35
PSR26	1-9/16" diameter	40 mm diameter	6	\$48.65
PSR30	1-7/8" diameter	48 mm diameter	8	\$55.35

NEW

Mount Style



Part #	Size (in)	Size (mm)	Max Lines	Price
PS25	1-1/8 x 3-7/8"	29 x 98 mm	7	\$61.95
PS31	2 x 2"	51 x 51 mm	13	\$65.35
PS33	2 x 3-1/8"	51 x 79 mm	13	\$73.35
PS35	2-3/8 x 3-1/8"	60 x 79 mm	15	\$76.35
PS37	1-5/8 x 4-15/16"	41 x 125 mm	10	\$76.35
RM32	2-1/2 x 3-1/4"	64 x 83 mm	13	\$70.95
RM34	3 x 4"	76 x 101 mm	19	\$80.35
PS41	3-1/8 x 4-1/2"	79 x 114 mm	21	\$88.95

Refill Ink for ALL PRE-INKED and FLASH stamps!

This ink is compatible with ALL pre-inked stamps including MaxLight, all Flash stamps, and older pre-inked stamps with raised characters.

Flash Refill Ink 1/4oz. - 7ml



XL21650	Black	\$14.65
XL21652	Blue	\$14.65
XL21651	Red	\$14.65
XL21653	Green	\$14.65
XL21654	Purple	\$14.65



Flat OR Raised Characters





CLASSIC RUBBER STAMPS

A classic custom stamp for all kinds of paper.

- Stamp pad required, sold separately
- Specialty inks and jumbo sizes available on page 14
- Deep moulds available for rougher surfaces

31-27 \$39.65

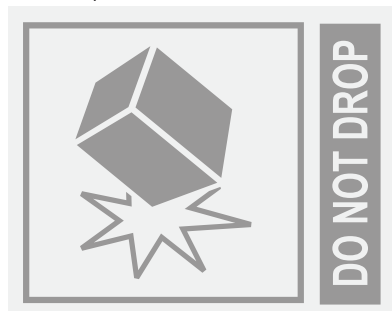

1-5/8 x 2" 41 x 51 mm
max. 10 lines

31-31 \$44.95

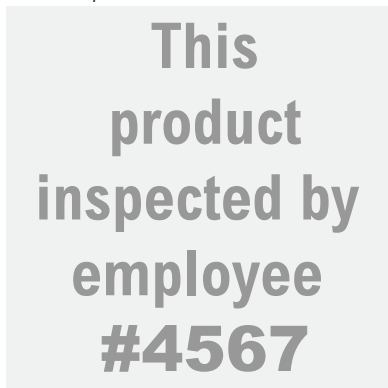

2 x 2" 51 x 51 mm
max. 13 lines

31-15 \$29.95



5/8 x 1-5/8" 16 x 41 mm
max. 4 lines

31-09 \$31.65



5/8 x 2-1/2" 16 x 64 mm
max. 4 lines

31-21 \$33.65

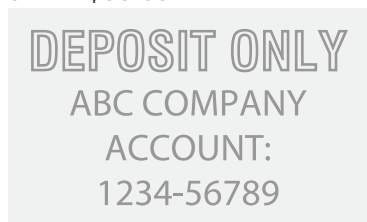

1-1/8 x 1-7/8" 29 x 48 mm
max. 7 lines

31-19 \$33.65



7/8 x 2-7/8" 22 x 73 mm
max. 6 lines

31-17 \$32.95



7/8 x 2-1/4" 22 x 57 mm
max. 6 lines

DRAFT PROOF

Please read contents carefully and approve. Please note any changes if required.

31-23 \$34.95

1-1/8 x 2-7/8" 29 x 73 mm
max. 7 lines

31-25 \$38.35



1-1/8 x 3-7/8" 29 x 98 mm
max. 7 lines

31-13 \$32.95

5/8 x 3-5/8" 16 x 92 mm
max. 4 lines

Where The Green Grass Grows Co.
Lawn and Garden Maintenance & Design
www.greengrassgrows.com



31-07 \$29.95

1/2 x 1-1/2" 13 x 38 mm
max. 3 lines

QUALITY CONTROL

31-03 \$24.35

Initials: _____ Date: _____
max. 3 lines

Make a really long stamp!

31-05 \$26.95

3/8 x 2-1/2" 10 x 64 mm
max. 3 lines

Trodat Stamp Pads

Classic stamp pad in recycled plastic case. Dry ink pads require a separate ink purchase.



Part #	Size	Price
9051	2 x 3-1/2"	\$8.95
9052	2-3/4 x 4-3/8"	\$10.35
9053	3-1/2 x 6-3/8"	\$19.35
9054	5-7/8 x 8-1/4"	\$26.65



Trodat Refill Ink

For stamp and self-inking swop pads only, not for re-inkable stamps.

Part #	Size	Price
7011	28ml	\$10.65





BREAKABLE CONTENTS

31-37 \$50.65

1-5/8 x 4-15/16" 41 x 125 mm
max. 10 lines

SHEET MUSIC ENCLOSED

Property of:

My Music Studios
23 Talbot Street W.
St. Thomas, Ontario

NOL 2GO

PLEASE RETURN

CONFIDENTIAL

FOR
INTERNAL
USE
ONLY

LAW OFFICE



31-35 \$49.95

2-3/8 x 3-1/8" 60 x 79 mm
max. 15 lines

31-33 \$46.65

2 x 3-1/8" 51 x 79 mm
max. 13 lines
(portrait oriented)



31-40 \$52.95

2-1/2 x 3-1/2" 64 x 89 mm
max. 16 lines
(portrait oriented)

31-29 \$41.35

1-5/8 x 2-7/8" 41 x 73 mm
max. 10 lines

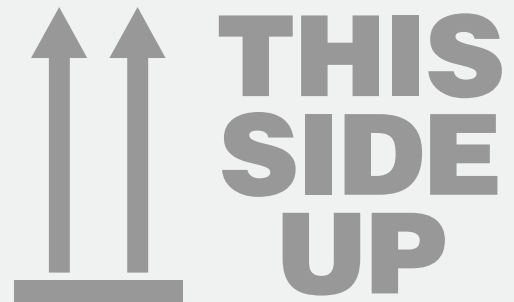

DIY CUSTOM STAMP



Unilok interchangeable letters & numbers (ex. shown has 2 ribs)

Unilok wood mount with ribbed rubber base

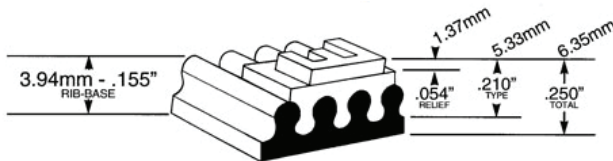

Type and base thickness held to +/- .003 Inch (+/- .08mm)

DIY Rubber Stamp Holders

Our DIY Unilok wood holder has a ribbed base which allows you to interchange different sized letters and numbers to multiple rows in order to create your custom message. Our DIY rubber stamp is compatible with the below Unilok letter & number sets. Larger sizes are available, call for quote!

Part #	Size (in)	Description	Price	# of ribs it can hold
L3	1/2 x 2-1/4"	Unilok Holder	\$21.35	2-3
L4	3/4 x 2-1/4"	Unilok Holder	\$23.65	2-4
L6	1 x 2-1/2"	Unilok Holder	\$23.65	2-4
L8	1-1/4 x 3"	Unilok Holder	\$27.65	2-6
L9	1-1/4 x 3-1/4"	Unilok Holder	\$28.35	2-6
L10	1-1/4 x 3-1/2"	Unilok Holder	\$30.95	2-6
L12	1-3/4 x 3-3/4"	Unilok Holder	\$33.65	2-8



DIY Rubber Stamp Letter & Number Sets

Interchange letters and/or numbers for your holder to create custom words, dates, and more!

Char. Height	Pt. Size	# of Ribs	Letter & Number Set Part#	Price	Number Set Only Part#	Price
7/64"	10	2	SLF09	\$41.95	SF09	\$23.65
1/8"	12	2	SLF10	\$42.35	SF10	\$23.65
3/16"	18	2	SLF12	\$44.35	SF12	\$23.65
3/8"	36	3	SLF15	\$70.65	SF15	\$30.95
3/4"	76	6	SLF78	\$133.95	SF78	\$47.95
15/16"	98	8	SLF79	\$133.95	SF79	\$56.35



SPECIALTY STAMPS

Special applications that need a custom stamp.

- For use with fast drying inks
- Marking on non porous and uneven surfaces
- Perfect for small businesses and DIY applications

Traditional Rubber Stamp + Deep Mould

Our traditional rubber stamps have photopolymer dies, perfect for marking on porous surfaces like paper, but if you're going to be stamping thicker porous surfaces (like corrugated cardboard) or for large stamps with a lot of detail, then the deeper mould ensures a quality impression on a larger variety of surfaces.



Natural Rubber

Recommended when stamping non porous surfaces that require fast-drying inks such as catalogues, photographs, metal, and varnished wood. Our natural rubber stamps will not swell when using fast dry ink, allowing a good impression every time you stamp.



Natural Rubber + Deep Mould

Natural Rubber Stamps with Deep Mould are recommended for oversize stamps with detailed logos, multiple lines in a thin font style, and stamp images containing large areas with no graphics to ensure all details and text are legible ensuring a quality stamp impression.

Rocker Mount

For uneven surfaces or areas with mild recess, a deep mould with a rocker mount is recommended. Best for wood and corrugated cardboard. Price includes mount and stamp.

Part #	Size (in)	Size (mm)	Price
RM1	5-3/4 x 4"	146 x 102 mm	\$147.95
RM2	5-3/4 x 6"	146 x 152 mm	\$171.65
RM3	5-3/4 x 8"	146 x 203 mm	\$194.95
RM4	5-3/4 x 10"	146 x 254 mm	\$218.95



Natural Rubber + Deep mould on a Rocker mount with a Gate Handle stamped on a corrugated cardboard box

Specialty Rubber Stamp

Size	Size (in)	Size (mm)	Traditional Rubber + Deep Mould	Natural Rubber	Natural Rubber + Deep Mould
31-03	3/8" x 1-7/8"	10 x 48 mm	31-03DM \$35.95	31-03T \$28.65	31-03TDM \$43.35
31-05	3/8" x 2--1/2"	10 x 64 mm	31-05DM \$39.65	31-05T \$31.95	31-05TDM \$47.65
31-07	1/2" x 1-1/2"	13 x 38 mm	31-07DM \$44.35	31-07T \$35.65	31-07TDM \$52.95
31-09	5/8" x 2-1/2"	16 x 64 mm	31-09DM \$46.35	31-09T \$37.35	31-09TDM \$55.65
31-13	5/8" x 3-5/8"	16 x 92 mm	31-13DM \$48.65	31-13T \$38.95	31-13TDM \$58.35
31-15	5/8" x 1-5/8"	16 x 41 mm	31-15DM \$44.65	31-15T \$35.95	31-15TDM \$53.95
31-17	7/8" x 2-1/4"	22 x 57 mm	31-17DM \$48.65	31-17T \$38.95	31-17TDM \$58.35
31-19	7/8" x 2-7/8"	22 x 73 mm	31-19DM \$49.95	31-19T \$39.95	31-19TDM \$59.35
31-21	1-1/8" x 1-7/8"	29 x 48 mm	31-21DM \$49.95	31-21T \$39.95	31-21TDM \$59.35
31-23	1-1/8" x 2-7/8"	29 x 73 mm	31-23DM \$51.95	31-23T \$41.35	31-23TDM \$61.95
31-25	1-1/8" x 3-7/8"	29 x 98 mm	31-25DM \$56.95	31-25T \$45.65	31-25TDM \$67.95
31-27	1-5/8" x 2"	41 x 51 mm	31-27DM \$58.95	31-27T \$47.35	31-27TDM \$69.65
31-29	1-5/8" x 2-7/8"	41 x 73 mm	31-29DM \$60.95	31-29T \$48.95	31-29TDM \$72.65
31-31	2" x 2"	51 x 51 mm	31-31DM \$66.65	31-31T \$53.65	31-31TDM \$79.35
31-33	2" x 3-1/8"	51 x 79 mm	31-33DM \$68.95	31-33T \$55.65	31-33TDM \$81.95
31-35	2-3/8" x 3-1/8"	60 x 79 mm	31-35DM \$74.35	31-35T \$59.95	31-35TDM \$88.65
31-37	1-5/8" x 4-15/16"	41 x 125 mm	31-37DM \$75.35	31-37T \$60.35	31-37TDM \$89.65
31-40	2-1/2" x 3-1/2"	64 x 89 mm	31-40DM \$78.65	31-40T \$62.95	31-40TDM \$93.35

H

Magnesium Dies

Use a custom magnesium die to mark on a variety of surfaces including leather, wax, pottery, soap, paper, cardboard, and soft metals (ex. jewelry). Prices shown are for 11pt magnesium. Contact us for a quote on unmounted magnesium dies of all sizes and 16gauge and 0.25" thicknesses.

Magnesium Die Size (11pt mag.)	Mag. with Wood Handle Only	Mag. Mounted to 0.765" Wood	Mag. Mounted to 0.75" Aluminum
3/4" x 3/4"	\$66.31	\$83.27	\$83.27
1" x 1"	\$69.69	\$88.05	\$88.05
1" x 1-1/2"	N/A	\$93.15	\$93.15
2" x 2"	N/A	\$113.55	\$113.55

Magnesium impression in pottery clay



Magnesium dies mounted on wood handles



Magnesium mounted on wood block



Magnesium mounted on aluminum block

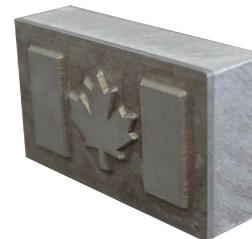

Fast Dry Inks for Natural Rubber Stamps

For marking on non porous surfaces you need: a dry stamp pad, fast dry ink, natural rubber stamp. Choose from the following inks for your specific application. Larger quantities can be found on page 50.

Part #	Application	Dry Time	Size	Price	Ink Colours
SM100-2	Tin, Glass, Plastic, Photos	15-20 sec.	2 oz	\$11.65	Black, Red, Blue, Green, Purple
1061-2	Opaque ink, Metal, Plastic	5-20 sec.	2 oz	\$11.95	Black, Red, Blue, Green, Purple, Yellow, White
850-2	Vinyl, Cellophane, Metal, Photos	2-20 sec.	2 oz	\$11.95	Black, Red, Blue, Green
SC-10-2	Solvent to clean fast dry ink stamp		2 oz	\$10.65	

Suitability and drying times may vary due to environment. Store ink and pad in ziplock bag when not in use.

Fast Dry Ink application examples on non porous surfaces with SM100-2 ink

G



Un-inked Muslin Pad for Specialty Inks

Premium un-inked muslin pad in a heavy duty metal case. Perfect for specialty inks and oversize stamps.

Part #	Size	Price
20062	2-3/4 x 4-1/4"	\$41.35
20063	3-1/2 x 5-1/8"	\$41.35
20064	4 x 6-1/8"	\$43.95
20068	5-1/8 x 9"	\$72.65
20070	7 x 11"	\$94.35



F

Trodat Stamp Pads

Classic stamp pad in recycled plastic case. Dry ink pads require a separate ink purchase.



Part #	Size	Price
9051	2 x 3-1/2"	\$8.95
9052	2-3/4 x 4-3/8"	\$10.35
9053	3-1/2 x 6-3/8"	\$19.35
9054	5-7/8 x 8-1/4"	\$26.65



Trodat Refill Ink

For stamp and self-inking swop pads only, not for re-inkable stamps.



Part #	Size	Price
7011	28ml	\$10.65

INSPECTOR STAMPS

Ideal for frequent buyer cards, bulk mail, initials, and numbers for inspection.

- Pre-inked or self-inking (no additional stamp pad required)
- Handy and durable
- For marking on bond paper only

Ink Colours



XStamper Pre-inked

Our highest quality stamp, extremely durable with superior quality for all uses. Re-inkable up to 50,000 impressions before re-inking.



N06 \$32.65

NO

1/4" 6 mm diameter
max. 2 lines



N30 \$33.65



3/8" 10 mm diameter
max. 2 lines



N32 \$37.95



5/8" 16 mm diameter
max. 3 lines



N60 \$30.95

INITIAL
HERE

1/2" 13 mm diameter
max. 2 lines

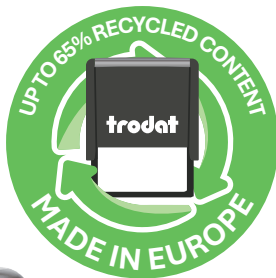

Trodat Self-Inking

Our most popular stamps, made in Europe and containing recycled plastic. Create separate stamps personalised to every inspector. Great for traceability and accountability.



4612 \$34.95

#4

7/16" 11 mm dia.
max. 2 lines
ink pad: 6/4612 \$12.35

46019 \$37.35



11/16" 18 mm dia.
max. 3 lines
ink pad: 6/46019 \$12.35

4921 \$34.65



7/16" x 7/16" 11 x 11 mm
max. 5 lines
ink pad: 6/4921 \$12.35

4922 \$37.65



3/4" x 3/4" 19 x 19 mm
max. 5 lines
ink pad: 6/4922 \$12.35



INDUSTRIAL STAMPS

XStamper's permanent and water resistant industrial stamps, are perfect for hard-to-mark surfaces and harsh manufacturing environments (see chart below).

- Pre-inked and re-inkable
- Ink dries in 90 - 120 seconds (varies)



Laser-engraved silicone rubber and airtight seal



F06 \$50.35

35

1/4" diameter
6 mm diameter
max. 2 lines

F11 \$56.35



1/2" diameter
13 mm diameter
max. 3 lines

F30 \$91.65



1-3/16" diameter
30 mm diameter
max. 6 lines



F10 \$80.65

LIMITED WARRANTY
ENCLOSED

BELOW WEIGHT

1/2 x 1-5/8" 13 x 41 mm
max. 4 lines
Example of white ink on dark surface.



Ink Application Guide

Excellent	
Art Paper	Acrylic Board
Construction Paper	A.B.S.
Corrugated Paper	Aluminum
Photographic Paper	Stainless Steel
Cotton Cloth	Brass
Cellophane	General Painted Surface
Polyester Film	
Good	
Letter Paper	Polypropylene
Tracing Paper	Hard PVC
Hard Tracing Paper	Soft PVC
Film Coated Paper	Styrofoam
Synthetic Fabric	Glass
Plywood	Ceramic
Leather	Melamine Coated Board
Fair	
Rubber	Polyethylene Film

Industrial Refill Inks and Solvent

20ml \$24.35



- | | |
|-------------|---------------|
| 24211 Red | 24215 Purple |
| 24212 Black | 24217 White* |
| 24213 Blue | 24218 Yellow* |
| 24214 Green | 24219 Solvent |

*White and yellow dry faster and are not fade resistant outside. Due to the special nature of this product and ink, please allow 2-3 weeks for delivery.





CLASSIC DIE PLATE DATERS

Ideal for invoices, tenders, bank deposits, and courier packages. Made in Europe from post-consumer recycled materials!

- Popular with bank tellers, can be customized with your logo
- Use with a stamp pad
- Minimum of 8 years, additional band layouts
- Available in French and ISO

English: **DEC 14 2032**
 French: **31 AVR 2032**
 ISO: **2032 - 12 - 31**

2910/P01 \$85.95



1-1/8 x 1-7/8"
 28 x 48 mm

2910/P02 \$85.95



1-7/16 x 1-15/16"
 36 x 49

MX4004 \$85.95

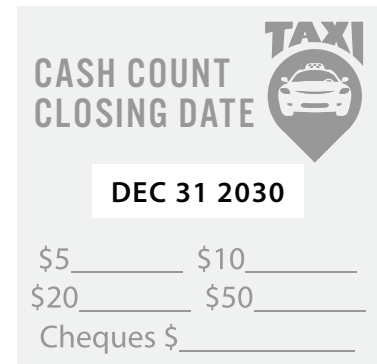

1-7/8" x 1-7/8"
 48 x 48 mm



*MX4004 is still MarkMaker style

2910/P10 \$92.95



1-7/8" x 2-11/16"
 48 x 68 mm



2910/P30 \$92.95

1-7/8" dia
 48 mm dia

2910/U12 \$101.95

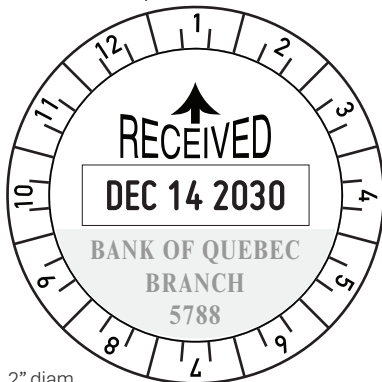

2" diam.
 50 mm diam.

2910/U24 \$101.95



2" diam.
 50 mm diam.

Only the area below date can be customized. The outer time ring spins around the unit.



SELF-INKING DATERS

Ideal for incoming mail and accounting records.

- Plastic daters are Made in Europe with recycled content
- Minimum of 8 year bands, additional band layouts available in French and ISO
- Customize with text and logos
- Built-in easy to change ink pad included

English: **DEC 14 2032**
 French: **31 AVR 2032**
 ISO: **2032 - 12 - 31**



Self-inking Daters



For our most **HEAVY DUTY DATERS** made of **STAINLESS STEEL**, head to our **PROFESSIONAL** section! PG. 4-5



4813 \$55.95

SHIPPED BY:
L. Simons

NEW
DEC 14 2030

textplate size 5/16 x 1" 8 x 26 mm
 ink pad: 6/4817 \$12.35
 3.8 mm date height

4750 \$73.95

CUSTOMISE YOUR
DEC 14 2030
MESSAGE HERE!

7/8 x 1-9/16" 23 x 39 mm
 ink pad: 6/4750 \$12.35
 ink pad: 6/4750/2 \$13.35
 4 mm date height

2 Colour Ink Pads

Are **BLUE** with **RED** middle. Part number has a "2" on the end.



4727 \$105.95



CONNECT

DEC 14 2030

Your service will start on the above date. Please contact us with any issues!

1-9/16 x 2-3/8" 39 x 60 mm
 ink pad: 6/4927 \$15.65
 ink pad: 6/4927/2 \$18.35
 4 mm date height

NEW

1147
Bear Rd.
Canada

4724 \$101.95



DEC 14 2030

EVEREST
BUSINESS

1-1/2 x 1-1/2" 38 x 38 mm
 ink pad: 6/4924 \$13.65
 ink pad: 6/4924/2 \$16.35
 3 mm date height

46130 \$68.95



1-3/16" 30 mm dia
 ink pad: 6/46030 \$12.35
 ink pad: 6/46030/2 \$13.35
 3 mm date height

46145 \$99.35



1-3/4" 44 mm dia
 ink pad: 6/46045 \$15.65
 ink pad: 6/46045/2 \$18.35
 3 mm date height

STOCK DATERS

Quick and easy date stamping!

- Available as classic dater (needs stamp pad) or Self-Inking (built-in)
- Stock daters are made in Europe with recycled content
- Additional band layouts may be available as special order & pricing
- Minimum of 8 year bands

English: **DEC 14 2032**
 French: **30 AVR 2032**
 ISO: **2032 - 12 - 31**
 Military*: **14 DEC 2032**
*available for 4810 only



Classic Stock Line Daters

Minimum of 8 years. Must be used with a stamp pad. Larger sizes available on quotation.



T1000 \$11.95
DEC 14 2030
 1/8", 3 mm

T1010 \$11.95
DEC 14 2030
 5/32", 4 mm

T1020 \$14.35
DEC 14 2030
 3/16", 5 mm



Stock Professional Self-inking Daters

Made in Europe with Stainless Steel! Our toughest line yet!
 Built-in and easy to replace ink pad.



5030 \$87.95
DEC 14 2030
 5/32" 4 mm date height
 ink pad: 6/50 \$11.35

5430-S2 \$82.95 NEW

PAID
DEC 14 2030

15/16 x 1-9/16" 24 x 40 mm
 5/32" 4 mm date height
 ink pad: 6/50/2 \$14.65

Choose from 6 other stock titles (shown smaller).
 Also available in French. All designs are \$82.95.

5430-S3 E-MAILED DEC 14 2030	5430-S9 FAXED DEC 14 2030	5430-S7 POSTED DEC 14 2030
5430-S1 RECEIVED DEC 14 2030	5430-S4 DRAFT DEC 14 2030	5430-S5 COPY DEC 14 2030

Stock Plastic Self-inking Daters

Built-in and easy to replace ink pad.
 Made in Europe with recycled content!



4750-S2 \$56.35 NEW

PAID
DEC 14 2030

7/8 x 1-9/16" 23 x 39 mm
 5/32" 4 mm date height
 ink pad: 6/4750/2 \$13.35

Choose from 6 other stock titles (shown smaller).
 Also available in French. All designs are \$56.35.

4750-S3 E-MAILED DEC 14 2030	4750-S9 FAXED DEC 14 2030 Page _____ of _____	4750-S7 POSTED DEC 14 2030
4750-S1 RECEIVED DEC 14 2030	4750-S4 DRAFT DEC 14 2030	4750-S5 COPY DEC 14 2030



4820 \$42.95
DEC 14 2030
 5/32" 4 mm date height
 ink pad: 6/4911 \$11.35



NEW
4810 \$23.95
14 DEC 2032
 1/8" 3.8 mm date height
 ink pad: 6/4910 \$11.35

VERSADATER® CUSTOM & STOCK

Extremely durable with superior quality for all uses!

- Pre-inked, stamp pad is built-in
- Re-inkable, up to 50,000 impressions before re-inking
- At least 8 year bands, changed by dial

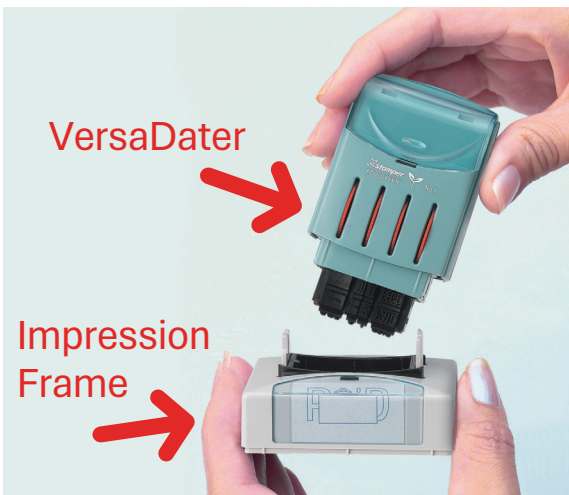

Mix and Match Design

Order just a Dater, just an Impression Frame, or both! Use your Dater on its own, or snap on any Impression Frame™. Order additional frames to mix and match! Customize your frame, or order a stock message.



VersaDater - Dater Only

Dater only, available in three colours. Use it on its own, or add a custom or stock Impression Frame below.

DEC 31 2030

52112 Black

DEC 31 2030

52111 Red

DEC 31 2030

52113 Blue

Dater Refill Ink

Refill for DATER section only. 5 tubes of 0.5g ink each.

22012	\$12.35	
22011	\$12.35	
22013	\$12.35	



Dater Only
\$62.35
1/4" x 1"
6 x 25 mm

Impression Frame

Create a custom Impression Frame or choose from a stock design below.



Ink Colours



Impression Frame Refill Ink



N100-10	10ml	\$11.95
N100-20	20ml	\$17.35
N100-60	60ml	\$37.95



N80 \$110.35 Dater + Custom Impression Frame
N81 \$62.95 Custom Impression Frame only (No Dater)

N82 \$98.35 Dater + Custom Impression Frame
N83 \$56.35 Custom Impression Frame only (No Dater)

SHIPPED

DEC 31 2030

1-3/4" x 2-1/2"
44 x 64 mm
max. 8 lines

**THANK YOU FOR YOUR XSTAMPER ORDER.
ALL RETURNS MUST BE MADE NO LATER
THAN 14 DAYS FROM THE ABOVE DATE.**



1-5/16 x 2-1/8"
33 x 54 mm
max. 4 lines

Stock VersaDater® \$79.95

Includes Impression Frame + Dater. Impression Frame is blue and Dater is red (as shown). Stock Impression Frames are only available in one size.

66210	PAID
66211	RECEIVED
66213	FAXED

Stock Impression Frame™ \$33.95

Stock Impression Frames are only available in one size.

66410	PAID - Impression Frame Only
66411	RECEIVED - Impression Frame Only
66413	FAXED - Impression Frame Only



1-5/16 x 2-1/8"
33 x 54 mm

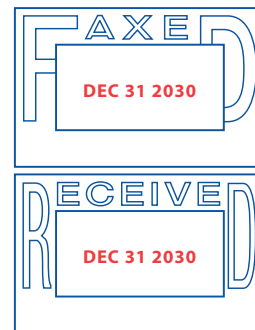

* examples shown smaller, actual size on left



CLASSIC STOCK NUMBERERS

Perfect for part numbering or coding on paper, labels, products, or cartons!

- Also available as a Trodat self-inking stamp or Professional self-inking stamp

Classic Stock Numbering Stamps **NEW**

European made with post-consumer recycled plastic! Classic numbering stamps with 4, 6, 8, 10, 12, 14, or 20 bands ranging from 3 to 18 mm in height. Must be used with a stamp pad. Combinations with letter bands A-M and N-Z or other figures, letters, signs, or larger heights, may be available upon request. A-M or N-Z bands can be added for \$19.95 per unit and with specified band placement. Part numbers and prices are shown below.

	1536 \$21.95				15310 \$43.65												
3mm 1/8"	1	2	3	4	5	6	7	8	9	0	1	2	3	4	5	6	7
	1534 \$19.95				1538 \$30.65				15312 \$53.45		15320 \$89.95						

4mm 5/32"	1	2	3	4	5	6	7	8	9	0	1	2
	1544 \$16.35		1546 \$18.35		1548 \$24.35		15410 \$36.35		15412 \$45.95			

5mm 3/16"	1	2	3	4	5	6	7	8	9	0	1	2	3	4
	1554 \$23.35		1556 \$27.95		1558 \$33.95		15510 \$47.65		15512 \$57.65		15514 \$58.95			

7mm 9/32"	1	2	3	4	5	6	7	8
	1574 \$39.95			1576 \$53.95			1578 \$63.95	

9mm 3/8"	1	2	3	4	5	6	7	8	9	0	1	2
	1594 \$47.65		1596 \$54.65		1598 \$69.95		15910 \$97.95		15912 \$100.65			

18mm 3/4"	1	2	3	4	5	6	7	8
	15184 \$125.35		15186 \$150.95		15188 \$165.95			

15mm 5/8"	1	2	3	4	5	6
	15156 \$141.35					

12mm 1/2"	1	2	3	4	5	6
	15126 \$139.95					



For our most **HEAVY DUTY NUMBERERS** made of **STAINLESS STEEL**, head to our **PROFESSIONAL** section! PG. 4-5



Automatic Self-inking Numbering Machine

This heavy duty numbering machine automatically repeats numbers or self-advances to consecutive numbers, for fast and reliable marking. Features 6 self-advancing bands on premium alloy wheels and a built-in easy to replace ink pad. Can repeat a number 0-6 times or 12 times before moving on to the next number. Includes 2 black ink cartridges and number changing tool.

5756 (TR-6) \$102.95

123456

6 bands
1/5" 5.5 mm character height

Ink Colour



Replacement Pads

57561-2	Black pads - 2 pack	\$24.95
57561-5	Black pads - 5 pack	\$52.95
575662-5	Dry pads - 5 pack	\$52.95



Industrial Numbering Machines are available upon request.

ELECTRONIC EMBOSSERS AND TIME STAMPS

Embossers are good for certificates, diplomas, and legal documents. Time Stamps are ideal for payroll, receiving, validating, and numbering your documents.



E-3 Electronic Embosser

Embossing single sheet certificates, diplomas, and legal documents is instantaneous and accurate with correct positioning every time.

- Single hand operation
- Pressure adjustment
- 1-1/2", 1-3/4" or 2" seal diameter

Available Options: Foot pedal, push button, guide shelf, visual counter, and security lock (as shown).

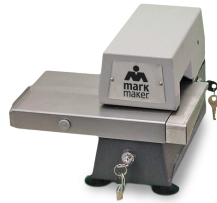

Part #	Description	Price
E-3	Embosser with metal seal	\$ 2,520.00
E-3-01	Additional metal seal	\$ 826.50
E32	Foot Pedal	\$ 377.45
E33	Security Lock	\$ 247.50
E34	Push Button	\$ 355.50
E35	Guide Shelf	\$ 352.00
E36	Visual Counter	\$ 497.75

Mark Maker T2E Power Embosser

Heavy duty electronic embosser does up to 15 sheets at once depending on paper stock, seal material, and seal diameter. T2E is super quiet and comes with a standard laser engraved plastic seal or a heavy duty CNC metal engraved seal. Both seals available from 1" to 2" diameter.

- Quiet operation - no noisy solenoid compressor
- Standard adjustable paper guides for precision embossing, paper activated micro-switch
- Keylocked to prevent unauthorized usage
- Adjustable pressure control
- Electronic controller and counter

Part #	Description	Price
T2E-MD	Power Embosser with metal seal	\$ 4695.00
T2E-PD	Power Embosser with plastic seal	\$ 3575.00
T2E-MD1	Replacement metal engraved seal	\$ 597.35
T2E-PD1	Replacement plastic engraved seal	\$ 99.95
T2E-FP	Foot Pedal accessory	\$ 165.65



T-3 Electronic Time Stamp

Compact and accurate time stamp delivers clean, crisp imprints.

- Instant trigger operation - just insert paper
- Quick ribbon change without mess
- Adjustable throat depth
- Tamper proof
- Customize the space above and below the time/date line
- Stamp layout: Year, Month, Day, A.M./P.M., Hour and Minutes

Part #	Description	Price
T-3	No clock face	\$1460.00
TLED3	Digital time display	\$1540.00
T3-1	Black ribbon	\$21.65
T3-12	Red ribbon	\$21.65
T3-13	Blue ribbon	\$21.65

*Extra charge for custom dies on quotation.

Optional Date/Time sequences available for an extra charge, call for quotation. Samples are actual size.



T-4U Electronic Dot Matrix Number, Time, Date Stamp/Printer

This multi-functional electronic time recorder has programmable text capabilities and a five year memory chip. Wall hung or desk mount.

- Adjustable trigger for imprint depth setting
- Wide selection of imprints available
- Penetrates through 3 copies of NCR
- Calendar never requires resetting (up to 2099)
- 3 Selectable comments, 5 languages, and numeric
- Prints left or right margin, 1/8"-1" from edge of document

Part #	Description	Price
T-4U	Dot matrix printer	\$618.50
3233BLK	Black ribbon cassette	\$41.35
3233RD	Red ribbon cassette	\$41.35



RECEIVED

2030 SEP 16 P 4: 02

TO BE DELIVERED

NAME OF VENDOR

SIGNATURE

FILED
LANDLORD & TENANT

2030 2 4 5 P 12: 50

CIVIL COURT
Calgary, AB, Canada

REC'D BOARD OF EDUCATION

2030 SEP 10 A 11:16

REVIEW UNIT-STAFF SECTION

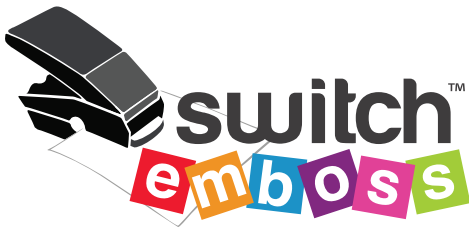

CLICK



EMBOSS



SWITCH

Great designs that are interchangeable in seconds!

- Creates raised impressions on paper: invitations, stationery, napkins, envelopes, cards, and more!
- Square or round designs up to 1-9/16" x 1-9/16" (40 mm)
- Environmentally friendly & cost-effective
- Hundreds of designs to choose from at www.switchemboss.ca

Switch Emboss

MONOGRAMS



Style: SW34



Style: SW54



Style: SW55



Style: SW71

NAME & ADDRESS



Style: SW213



Style: SW242

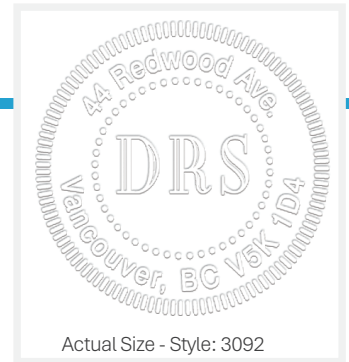

Actual Size - Style: 3092

SPECIAL OCCASIONS



Style: SW122



Style: SW125



Style: SW94



Style: SW108



Style: SW85



Style: SW90



Style: SW245



Style: SW259

AND MORE...

PC-IC \$42.15

Switch-in Designs

100's of designs to choose from at www.sterling.ca



PC3090 \$89.00

Switch Emboss Package

- 1 Embosser Frame
- 1 Switch-in Design



3090-B \$89.00

Switch Emboss Gift Box

- 1 Embosser frame
- 1 free online voucher for a Switch-in design



LEGAL AND NOTARY SEALS

For legal documents, notary seals, and certificates.

- Variety of pocket and desk seals
- Creates an elegant raised impression on paper
- Seal or notarize your most important documents
- MarkMaker's award winning embosser is lightweight, stackable, and has a collapsible handle



MarkMaker Embosser Legal Seal with Custom Brass Plate

Part #	Size	Price
3090	Size #1: 1-9/16" dia.	\$89.00



Actual Size #1



D

Pocket Seal with vinyl pouch

Part #	Size	Price
1005	Size #1: 1-9/16" dia.	\$92.85
1007	Size #2: 1-7/8"	\$92.85



D

Desk Seal

Part #	Size	Price
1000	Size #1: 1-9/16" dia.	\$94.55
1002	Size #2: 1-7/8"	\$94.55



D

Long Reach Heavy Duty Desk Seal

Part #	Size	Price
1003	Size #1: 1-9/16" dia.	\$129.00
1004	Size #2: 1-7/8"	\$129.00



D

Artistic Desk Seal with custom nameplate

Part #	Size	Price
1008	Size #1: 1-9/16" dia.	\$140.10

Legal & Notary Seals

Style Examples - see actual size above, more styles available.



Style #2

Style #25

Style #12

Style #40

Style #1

Style #4

Style #20

Style #21

Style #22

Mark Maker Embosser Notary Seal

Simply select your province (Quebec not available), and your custom text. Each Mark Maker Notary Seal comes with a custom brass plate.

Part #	Size	Price
3090-NTY	Size #1: 1-9/16" dia.	\$89.00

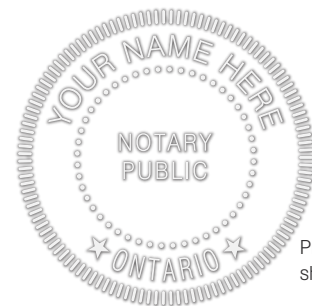

Provincial example shown actual size #1



Impression Inker

Applies black ink to embossed impression for photocopying or faxing purposes.

Part #	Size	Price
99600	Size #1: 1-9/16" dia.	\$35.65



Mark Maker Minute Book Kits

Everything you need to maintain your corporation. Each minute book comes with a customized plate on it, custom cover sheet, stock certificates, tab set, ledger sheet, paper, and a Mark Maker Embosser Legal Seal with custom brass plate.

Part #	Description
3080M	Mark Maker Attache Kit (black leatherette case)
3080-4M	Mark Maker Portfolio Kit (black zippered binder)
3085M	Mark Maker Legacy Kit (burgundy binder & slip case)

Available through our extensive dealer network. Contact us for the dealer nearest you.



PRINT SERVICES

Comprehensive Print Solutions Tailored to Your Needs!

We offer a full spectrum of printing services to support your business—from fast digital printing for small orders to traditional offset printing for large, high-quality runs. Our in-house bindery ensures your projects are finished with precision and care, whether you need booklets, brochures, or custom packaging. Plus, with our inventory management services, we help you stay organized and efficient, ensuring your materials are always ready when you need them. Partner with us for reliable, end-to-end print solutions that deliver results.

BUSINESS CARDS

Business Cards That Represent Your Brand with Precision!

Our business cards are crafted using premium materials and advanced printing technology to ensure exceptional colour accuracy and image clarity—perfectly aligned with your brand standards. Whether you choose digital or offset production, each card is produced with expert attention to detail and backed by our quality assurance team. With fast turnaround times and a variety of finishes and styles, we deliver business cards that make a lasting impression.



Classic
This card stock offers everyday reliability with excellent quality.

Executive
This heavier weight card stock offers a thicker, more rigid and durable business card.



Matte vs. Glossy

Matte cards offer a smooth, non-reflective surface that gives a refined, understated look with excellent readability—ideal for professional and minimalist designs. Glossy cards, on the other hand, feature a shiny, high-impact finish that enhances colour vibrancy and image sharpness, perfect for bold visuals and eye-catching branding.

Vibrant Colour Business Cards

Printed in rich, full colour on both sides, these cards deliver bold visuals and sharp detail that bring your brand to life. Perfect for highlighting logos, imagery, and contact info with style and clarity.

EXECUTIVE				CLASSIC			
Part #	Finish	Qty	Price	Part #	Finish	Qty	Price
BCDP-EG	Gloss	100	\$30.99	BCDP-CG	Gloss	100	\$29.49
		250	\$42.99			250	\$40.49
		500	\$57.49			500	\$53.49
BCDP-EM	Matte	100	\$32.49	BCDP-CM	Matte	100	\$28.99
		250	\$45.99			250	\$39.49
		500	\$63.99			500	\$52.99



Part #BCDP-EM



Part #BCFCR-EG

Oil Canvas Business Cards

Elevate your brand with a truly tactile experience—these premium cards feature a unique, raised texture applied to all printed areas, creating a canvas-like feel that adds depth and distinction to your design. Perfect for making a memorable impression with every touch.

EXECUTIVE				CLASSIC			
Part #	Finish	Qty	Price	Part #	Finish	Qty	Price
BCFCR-EG	Gloss	100	\$40.99	BCFCR-CG	Gloss	100	\$39.49
		250	\$59.49			250	\$57.49
		500	\$89.99			500	\$86.49

Raised Gloss Business Cards

Add dimension and shine where it matters most. This premium card option features a raised, glossy coating applied selectively to key design elements creating a striking contrast against the paper surface for a bold, tactile finish that demands attention.

EXECUTIVE				CLASSIC			
Part #	Finish	Qty	Price	Part #	Finish	Qty	Price
BCSGR-EG	Gloss	100	\$55.99	BCSGR-CG	Gloss	100	\$54.49
		250	\$74.49			250	\$72.49
		500	\$104.99			500	\$101.49



Part #BCSGR-EG



Part #BCFCUV-EG

Ultra Gloss Business Cards

Designed to shine—literally. These cards feature a high-impact UV coating that amplifies colour vibrancy and delivers a sleek, mirror-like finish. The added gloss not only enhances visual appeal but also provides extra durability, making your brand look brilliant and built to last.

EXECUTIVE				CLASSIC			
Part #	Finish	Qty	Price	Part #	Finish	Qty	Price
BCFCUV-EG	Gloss	100	\$35.99	BCFCUV-CG	Gloss	100	\$34.49
		250	\$50.49			250	\$48.99
		500	\$67.99			500	\$64.49

Soft Feel Laminated Business Cards

Experience elegance and durability in one. These cards are finished with a smooth, matte laminate that adds a soft-touch feel while reinforcing the card's strength—perfect for a refined look.

EXECUTIVE				CLASSIC			
Part #	Finish	Qty	Price	Part #	Finish	Qty	Price
BCLST-E	Matte	100	\$43.49	BCLST-C	Matte	100	\$41.99
		250	\$63.99			250	\$60.99
		500	\$90.49			500	\$84.99



Part #BCLST-E



Part #BCSP-E

Synthetic Paper Business Cards

Engineered for ultimate durability and standout appeal, these cards are printed on unique synthetic stock that resists tearing, water, and wear. With a smooth finish and bold colour reproduction, they offer a distinctive look and feel that sets your brand apart—perfect for high-impact, long-lasting impressions.

EXECUTIVE				CLASSIC			
Part #	Finish	Qty	Price	Part #	Finish	Qty	Price
BCSP-E	Gloss	100	\$47.49	BCSP-C	Gloss	100	\$43.49
		250	\$78.49			250	\$71.49
		500	\$128.99			500	\$114.99



ENVELOPES & LETTERHEADS

A wide range of envelope options with vibrant full-colour printing to match your brand!

Complete your print projects with envelopes that deliver both function and style. Available in a range of sizes and custom print options, they're perfect for everything from everyday mailings to branded communications.

Envelopes

Part #	Description	Qty	Price
E10RDP-C	Vibrant Colour Letter Envelope	250	\$105.49
		500	\$156.49
		1000	\$260.49
E10WDP-C	Vibrant Colour Letter Envelope with Window	250	\$107.49
		500	\$160.99
E10ADP-C	Vibrant Colour Letter Envelope with Security	250	\$108.99
		500	\$163.99
		1000	\$275.49
LHDP-C	Vibrant Colour Letterhead	250	\$65.49
		500	\$119.99
		1000	\$192.99
E912BKDP-C	Vibrant Colour 9x12 Open Side Envelope	250	\$136.49
		500	\$217.99
		1000	\$393.99
E912CATDP-C	Vibrant Colour 9x12 Open End Envelope	250	\$139.49
		500	\$224.49
		1000	\$405.99



Print Services



POSTCARDS

Eye-catching promotional postcards designed to connect with your audience!

A bold and versatile way to connect, promote, or inform. Our postcards are printed in vibrant colour on durable stock, perfect for direct mail campaigns, event promotions, or branded handouts that make an impact.

Vibrant Colour 5x7 Postcard

EXECUTIVE				CLASSIC			
Part #	Finish	Qty	Price	Part #	Finish	Qty	Price
57PCDP-EG	Gloss	100	\$50.49	57PCDP-CG	Gloss	100	\$45.99
		250	\$95.99			250	\$84.99
		500	\$166.99			500	\$143.99
57PCDP-EM	Matte	100	\$55.49	57PCDP-CM	Matte	100	\$44.99
		250	\$109.99			250	\$82.99
		500	\$189.99			500	\$136.99

Raised Gloss 5x7 Postcard

EXECUTIVE				CLASSIC			
Part #	Finish	Qty	Price	Part #	Finish	Qty	Price
57PCSGR-EG	Gloss	100	\$99.99	57PCSGR-CG	Gloss	100	\$95.49
		250	\$160.49			250	\$148.99
		500	\$249.00			500	\$226.49



Part # 57PCDP-CM



Part # 57PCSGR-EG



BROCHURES

Compact trifold brochures that deliver your message with impact!

Inform, engage, and impress with custom brochures printed in vibrant colour on quality stock. Available in a variety of folds and finishes, they're perfect for highlighting products, services, or event details in a polished, easy-to-read format.

Vibrant Colours Trifold Brochure

This eye-catching 6-panel brochure folds down to a sleek 8.5" x 3.5", making it perfect for displaying detailed content in a compact format.

EXECUTIVE				CLASSIC			
Part #	Finish	Qty	Price	Part #	Finish	Qty	Price
TBDP-EG	Gloss	100	\$67.49	TBDP-CG	Gloss	100	\$56.49
		250	\$133.49			250	\$106.99
		500	\$209.49			500	\$156.49
TBDP-EM	Matte	100	\$64.49	TBDP-CM	Matte	100	\$55.49
		250	\$126.49			250	\$103.99
		500	\$195.49			500	\$150.99



Part #TBDP-EG



Part # TBFCUV-EG

Ultra Gloss Trifold Brochure

Finished with a high-gloss UV coating, these brochures shine with vibrant colour and added durability—perfect for bold designs that demand attention.

EXECUTIVE				CLASSIC			
Part #	Finish	Qty	Price	Part #	Finish	Qty	Price
TBFCUV-EG	Gloss	100	\$106.99	TBFCUV-CG	Gloss	100	\$98.49
		250	\$207.99			250	\$186.49
		500	\$333.99			500	\$290.49

Print Services

POSTERS F

Indoor use only. Printed on 8 mil glossy paper. Laminate option protects from handling & UV rays.

Size	No Laminate						With Laminate					
	Part#	1-9	10-24	25-49	50-99	100+	Part#	1-9	10-24	25-49	50-99	100+
12" x 24"	DP1224	\$18.15	\$16.34	\$14.52	\$13.61	\$12.71	DP1224L	\$25.95	\$23.36	\$20.76	\$19.46	\$18.17
18" x 24"	DP1824	\$21.80	\$19.62	\$17.44	\$16.35	\$15.26	DP1824L	\$30.90	\$27.81	\$24.72	\$23.18	\$21.63
24" x 24"	DP2424	\$25.90	\$23.31	\$20.72	\$19.43	\$18.13	DP2424L	\$36.35	\$32.72	\$29.08	\$27.26	\$25.45
22" x 28"	DP2228	\$26.60	\$23.94	\$21.28	\$19.95	\$18.62	DP2228L	\$37.20	\$33.48	\$29.76	\$27.90	\$26.04
24" x 36"	DP2436	\$32.90	\$29.61	\$26.32	\$24.68	\$23.03	DP2436L	\$45.65	\$41.09	\$36.52	\$34.32	\$31.96
36" x 36"	DP3636	\$44.05	\$39.65	\$35.24	\$33.04	\$30.84	DP3636L	\$60.55	\$54.50	\$48.44	\$45.41	\$42.39
36" x 48"	DP3648	\$55.20	\$49.68	\$44.16	\$41.40	\$38.64	DP3648L	\$75.30	\$67.77	\$60.24	\$56.48	\$52.71
48" x 48"	DP4848	\$69.95	\$62.96	\$55.96	\$52.46	\$48.97	DP4848L	\$94.95	\$85.46	\$75.96	\$71.21	\$66.47

DPM Custom size > 17sqft with no laminate \$4.25/sqft DPML Custom size > 17sq/ft with laminate \$5.90/sqft

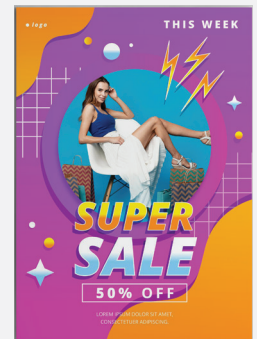

ONLINE PRINT MANAGEMENT

Streamlined online solutions for businesses needing ongoing, customizable print on demand!

We specialize in print management programs for businesses with single or multiple locations, who use print as part of their service offering. Custom web portal included!

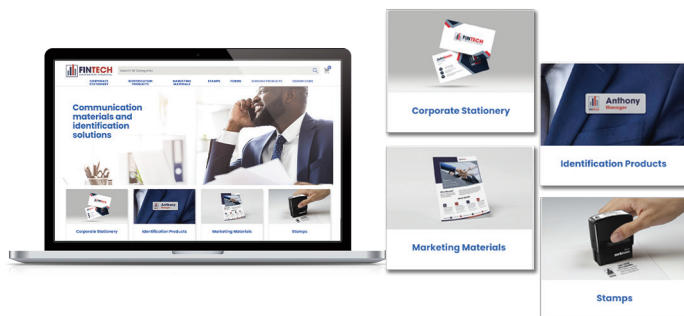

Management Tools

- reduce administration
- control product branding
- manage inventory
- optional order approval
- handle multiple products

Web Portal

- extremely customizable items
- employee ordering
- logo branded
- secure

Shipping & Billing

- instant order receipt
- consolidated billing
- several shipping methods

Job Production

- prices shown
- print preview
- easy to use templates



ENGRAVED NAME BADGES

Laser engrave your name or logo! Maintain a professional brand with matching name badges and nameplates!

START HERE! CHOOSE YOUR COLOUR & FONT!

More colours and fonts available.

X01	X02	X03	X59	X06	X25	X26	X32	G62	G61	413	417	X17
Black / White	White / Black	Red / White	Green / White	Yellow / Black	White / Red	White / Blue	Walnut / White	Blue / Yellow	Black / Yellow	Black / Silver	Black / Gold	Grey / White

X44	X45	X43	X46	344	X47	G63	Z17	842	X16	Z03	X08	X14
Brushed Alum./ Black	Brushed Alum./ Blue	Brushed Brass / Black	Polished Gold / Black	Smooth Silver / Black	Polished Silver / Black	Red / Yellow	Orange / White	Dark Brown / White	Royal Blue / White	Apple Green / White	Sapphire Blue / White	Burgundy / White

Times Roman*
Clarendon*

Brush Script
Helvetica*

Palacio*
Verdana

Cooper
Omega*
Gothic

Goudy
Futura
Script

*Available in Bold

Quantity Discounts			
10%	20%	25%	30%
10-24	25-49	50-99	100+

Standard Engraved Plastic Name Badge

Available with magnetic fastener or pinback. Magnetic fasteners will never ruin your clothing or poke you! Up to 3 lines of engraving included. Additional lines are \$3.00 each.

Size #	MAGNET		PINBACK	
	Part #	1-9	Part #	1-9
3 x 3/4"	214-3M	\$14.35	214-3	\$12.30
3 x 1"	214-4M	\$15.80	214-4	\$13.45
3 x 1-1/4"	214-7M	\$17.60	214-7	\$15.40
3 x 1-1/2"	214-8M	\$18.55	214-8	\$16.35
3-1/2 x 1"	214-5M	\$16.95	214-5	\$15.05
3-1/2 x 1-1/4"	214-6M	\$18.45	214-6	\$16.15

LOGO-2 Logo Setup Charge (one time) \$24.95

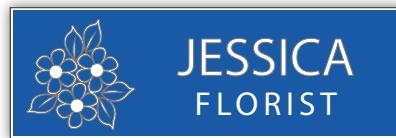
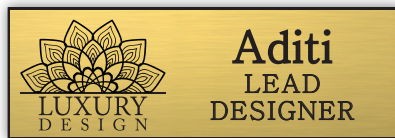

Name Badge Accessories

Magnet

Protects clothing from pin holes. Not for use with pace makers.

Part #	Price
BH1-4	\$3.00
BH1-5	\$4.15 extra strong
(to upgrade to an extra strong magnet, add \$1.15 to above Magnet Badge price)	



Pinback

Economical and easy to use.

Part #	Price
PV-10P	\$0.80



Double Clutch

Used for traditional applications.

Part #	Price
B-11	\$2.75
(to upgrade to a double clutch, add \$1.95 to above Pinback Badge price)	



Badge Holder

Protects up to two badges and holds magnets and business cards.

Part #	Price
214-75	\$2.70

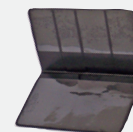

Blank Engraving Material - Rotary or Laser

QUANTITY DISCOUNTS DO NOT APPLY

G

Colours shown above, additional are available. Also available in 3-ply and other pre-cut sizes.

ROTARY Sheet Sizes: FULL 50 x 21 x 1/16". HALF: 25 x 21 x 1/16".

Rotary Material Description	FULL Sheet Part #	FULL Sheet Price	HALF sheet Part #	HALF sheet Price
Standard	232-50S	\$78.55	232-25S	\$39.35
Wood Grain	232-50W	\$78.55	232-25W	\$39.35
Metal / Reflective	232-50M	\$106.95	232-25M	\$54.00

LASER Sheet Sizes: FULL 48 x 24 x 1/16". HALF: 24 x 24 x 1/16".

Laser Material Description	FULL Sheet Part #	FULL Sheet Price	HALF sheet Part #	HALF sheet Price
Standard	232-48S	\$116.35	232-24S	\$59.95
Wood Grain	232-48W	\$116.35	232-24W	\$59.95
Metal / Reflective	232-48M	\$116.35	232-24M	\$59.95

ENGRAVED NAMEPLATES

Custom laser engraved with your name or logo, and can be wall or desk mounted. All styles come in 8" or 10" lengths.

- Start by choosing your colour, type style, size, and then the type of holder!

Quantity Discounts			
10%	20%	25%	30%
10-24	25-49	50-99	100+

Standard Engraved Wall or Desk Nameplates

Up to 3 lines of engraving. Choice of gold tone, silver, or black holder. Adhesive back is included for all complete wall plates (plate and holder), but must be requested and specified at that time of order.

Part #	Description 2 x 8"	Price	Part #	Description 2 x 10"	Price
28S	Nameplate only	\$17.75	210S	Nameplate only	\$19.20
28D	with desk holder	\$34.20	210D	with desk holder	\$38.10
28W	with wall holder	\$27.20	210W	with wall holder	\$29.35



Additional Services

Part #	Description	Price
LOGO-2	Logo Setup Charge (one time)	\$24.95
BRaille	Add Braille (per sign)	\$17.50
ADA	Add ADA Raised text and icons (per sign)	\$15.00

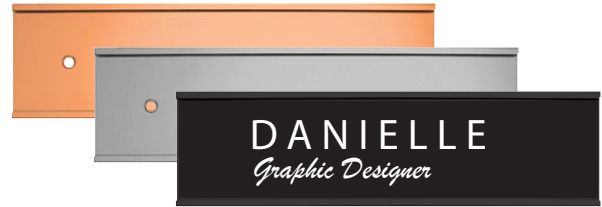

NEW

Engraved Designer Wall & Desk Nameplates

Up to 3 lines of engraving. Choose between square or rounded corners. Velcro or adhesive backings are also available. See colour combination options on page 30.



ROUNDED CORNERS

SIZE: 2 X 8"

Part #	Description	1-9
DBR28S	Plate only	\$18.95
DBR28D	Black frame, desk mini base	\$36.70
DBR28W	Black frame, no backing	\$34.95
DBR28WA	Black frame, adhesive back	\$36.70
DBR28WV	Black frame, velcro back	\$37.20

SIZE: 2 X 10"

Part #	Description	1-9
DBR210S	Plate only	\$20.30
DBR210D	Black frame, desk mini base	\$39.45
DBR210W	Black frame, no backing	\$37.70
DBR210WA	Black frame, adhesive back	\$39.45
DBR210WV	Black frame, velcro back	\$39.95

SQUARE CORNERS

SIZE: 2 X 8"

Part #	Description	1-9
DBS28S	Plate only	\$17.75
DBS28D	Black frame, desk mini base	\$35.50
DBS28W	Black frame, no backing	\$33.75
DBS28WA	Black frame, adhesive back	\$35.50
DBS28WV	Black frame, velcro back	\$36.00

SIZE: 2 X 10"

Part #	Description	1-9
DBS210S	Plate only	\$19.20
DBS210D	Black frame, desk mini base	\$38.35
DBS210W	Black frame, no backing	\$36.60
DBS210WA	Black frame, adhesive back	\$38.35
DBS210WV	Black frame, velcro back	\$38.85

LOGO-2 : Logo set up charge (one time only) | \$24.95



Meeting Room Status Sign

Your choice of plastic colour, to be wall mounted. Up to 3 lines. Adhesive back is available for all complete wall plates (plate and holder), but must be requested and specified at that time of order. Holders available in black and silver with black end clips.

Part #	Size	Price
212-208	2" x 8"	\$54.95
212-210	2" x 10"	\$60.65



Double Sided Hallway Signage

Double sided signage with mounting bracket included. Choice of gold tone or silver.

Part #	Max. Lines	Size	Price
28T	2	2-1/2 x 8"	\$52.00
210T	2	2-1/2 x 10"	\$57.00
48T	4	4 x 8"	\$63.75
410T	4	4 x 10"	\$68.45



FULL COLOUR NAME BADGES

Custom name badges offer professional identification for your staff.

- Variety of shapes and sizes to suit your needs
- Brass plated, silver aluminum, glossy white aluminum, or glossy plastic



Brass Plated



White Aluminum

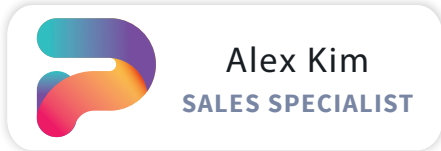

White Aluminum



Silver Aluminum



Quantity Discounts			
20%	30%	40%	45%
10-24	25-49	50-99	100+

Metal - Full Colour Name Badges

Full colour dye sublimation on 0.020" Aluminum with rounded corners. White ink on brass or silver only available by quotation.

- Most rigid and durable
- Elegant look
- Popular

Material	Size #	MAGNET		PINBACK	
		Part #	1-9	Part #	1-9
Brass Plated	1 x 3"	214-13B	\$21.35	214-13BPB	\$19.45
Brass Plated	1-1/4 x 3"	214-132B	\$21.70	214-132BPB	\$19.75
Brass Plated	1-1/2 x 3"	214-133B	\$22.00	214-133BPB	\$20.10
Brass Plated	2 x 3"	214-135B	\$22.30	214-135BPB	\$20.40
Silver Aluminum	1 x 3"	214-13A	\$21.35	214-13APB	\$19.45
Silver Aluminum	1-1/4 x 3"	214-132A	\$21.70	214-132APB	\$19.75
Silver Aluminum	1-1/2 x 3"	214-133A	\$22.00	214-133APB	\$20.10
Silver Aluminum	2 x 3"	214-135A	\$22.30	214-135APB	\$20.40
White Aluminum	1 x 3"	214-131	\$21.35	214-131PB	\$19.45
White Aluminum	1-1/4 x 3"	214-132	\$21.70	214-132PB	\$19.75
White Aluminum	1-1/2 x 3"	214-133	\$22.00	214-133PB	\$20.10
White Aluminum	2 x 3"	214-135	\$22.30	214-135PB	\$20.40

LOGO-2 : Logo set up charge (one time only) | \$24.95

Full Colour Name Badges

NEW

Plastic - UV Full Colour Badges

Full colour UV print on 0.060" standard engraving plastic (square or rounded corners as specified). Recommended plastics are X02 white with black back, X43 brushed gold with black back, and X44 brushed silver with black back.

- Rigid and durable
- Great economical alternative
- Able to print white

PINBACK

Part #	Size #	1-9
UV214-3	3/4 x 3"	\$13.80
UV214-4	1 x 3"	\$14.95
UV214-5	1 x 3 1/2"	\$16.55
UV214-6	1 1/4 x 3 1/2"	\$17.65
UV214-7	1 1/4 x 3"	\$16.90
UV214-8	1 1/2 x 3"	\$17.85
UV214-9	1 1/4" x 3" Oval	\$16.90

MAGNET

Part #	Size #	1-9
UV214-3M	3/4 x 3"	\$15.85
UV214-4M	1 x 3"	\$17.30
UV214-5M	1 x 3 1/2"	\$18.45
UV214-6M	1 1/4 x 3 1/2"	\$19.95
UV214-7M	1 1/4 x 3"	\$19.10
UV214-8M	1 1/2 x 3"	\$20.05
UV214-9M	1 1/4" x 3" Oval	\$19.10

LOGO-2 : Logo set up charge (one time only) | \$24.95



Quantity Discounts			
20%	30%	40%	45%
10-24	25-49	50-99	100+

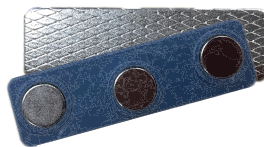

NEW

White Styrene Plastic - UV Full Colour Badges

Full colour UV print on 0.060" thick white styrene plastic (square or rounded corners as specified).

- Flexible • Good economical alternative • Only available in white



Quantity Discounts			
20%	30%	40%	45%
10-24	25-49	50-99	100+

PINBACK

Part #	Size #	1-9
UVS214-3	3/4 x 3"	\$12.80
UVS214-4	1 x 3"	\$13.95
UVS214-5	1 x 3 1/2"	\$15.55
UVS214-6	1 1/4 x 3 1/2"	\$16.65
UVS214-7	1 1/4 x 3"	\$15.90
UVS214-8	1 1/2 x 3"	\$16.85
UVS214-9	1 1/4" x 3" Oval	\$15.90



MAGNET

Part #	Size #	1-9
UVS214-3M	3/4 x 3"	\$14.85
UVS214-4M	1 x 3"	\$16.30
UVS214-5M	1 x 3 1/2"	\$17.45
UVS214-6M	1 1/4 x 3 1/2"	\$18.95
UVS214-7M	1 1/4 x 3"	\$18.10
UVS214-8M	1 1/2 x 3"	\$19.05
UVS214-9M	1 1/4" x 3" Oval	\$18.10



LOGO-2 : Logo set up charge (one time only) | \$24.95

IDENTIFICATION

Custom ID badges that are perfect for luggage, events, and more!

Quantity Discounts			
20%	30%	40%	45%
10-24	25-49	50-99	100+



Full Colour Aluminum Identification Badge

Glossy photo quality with up to 5 lines of copy and includes slip slot as shown. Double sided print add 25%.

Different photo on each badge add \$3 per badge. Fastener not included.

Part #	Size	1-9
214-134	2 x 3-1/2"	\$23.45
LOGO-2	Logo Setup Charge	\$24.95
	Vector Art Supplied	



Full Colour Name Badges

ACCESSORIES

Quantity Discounts			
5%	10%	15%	20%
10-24	25-49	50-99	100+

Alligator Clip

Ideal for badges that need to swivel. Easily clipped to a lanyard, badge, pocket, or garment.

Part #	Description	Price
B16A	Clip with strap	\$1.10



Lanyard

3/8" x 35" with bulldog clip and safety breakaway.

Part #	Colour	Price
B211	Black	\$3.35
B2161	White	\$3.35

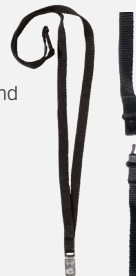

6" Clear Plastic Strap

For attaching your badge to a suitcase or luggage.

Part #	Price
B2410	\$0.75



FULL COLOUR NAMEPLATES

Custom nameplates offer professional identification for all staff or front desk. Choose from: Brass Plated, Silver Aluminum, White Aluminum.

- Logos and pictures in brilliant full colour
- Get matching badges for a fully branded look (see page 32)
- White ink on metal is available, call or email for quote



Quantity Discounts			
10%	20%	25%	30%
10-24	25-49	50-99	100+

Metal Full Colour Nameplates

Brass Plated • Silver Aluminum • White Aluminum
1/32" thick with full colour graphics. Metal holder comes in gold tone, silver, or black. White ink on metal is available, call or email for quote. Adhesive back is included for all complete wall plates (plate and holder), but must be requested and specified at that time of order.

- Brass Plated, Silver Aluminum, White Aluminum
- Logo set up charge (one time only) - \$24.95

Part No.	Size	Description	1-9
220-11	2" x 8"	Nameplate only	\$26.70
220-21	2" x 8"	With desk holder	\$43.00
220-31	2" x 8"	With wall holder	\$36.00
220-41	2" x 10"	Nameplate only	\$28.75
220-51	2" x 10"	With desk holder	\$47.50
220-61	2" x 10"	With wall holder	\$38.75



NEW

Designer Wall & Desk - Full Colour

Brass Plated • Silver Aluminum • White Aluminum
1/32" thick plate with full colour graphics mounted within plastic frame.. White ink on metal is available, call or email for quote.



ROUNDED CORNERS

SIZE: 2 X 8"

Part #	Description	1-9
220-DBR28S	Plate only	\$27.90
220-DBR28D	Black frame, desk mini base	\$45.65
220-DBR28W	Black frame, no backing	\$43.90
220-DBR28WA	Black frame, adhesive back	\$45.65
220-DBR28WV	Black frame, velcro back	\$46.15

SIZE: 2 X 10"

Part #	1-9
220-DBR210S	\$29.85
220-DBR210D	\$49.00
220-DBR210W	\$47.25
220-DBR210WA	\$49.00
220-DBR210WV	\$49.50

SQUARE CORNERS

SIZE: 2 X 8"

Part #	Description	1-9
220-DBS28S	Plate only	\$26.70
220-DBS28D	Black frame, desk mini base	\$44.45
220-DBS28W	Black frame, no backing	\$42.70
220-DBS28WA	Black frame, adhesive back	\$44.45
220-DBS28WV	Black frame, velcro back	\$44.95

SIZE: 2 X 10"

Part #	1-9
220-DBS210S	\$28.75
220-DBS210D	\$47.90
220-DBS210W	\$46.15
220-DBS210WA	\$47.90
220-DBS210WV	\$48.40

Full Colour Nameplates

NAMEPLATE HOLDERS & BACKERS

- Holders are only available for Standard Engraved and Standard Full Colour Nameplates.
- Nameplates sold separately.

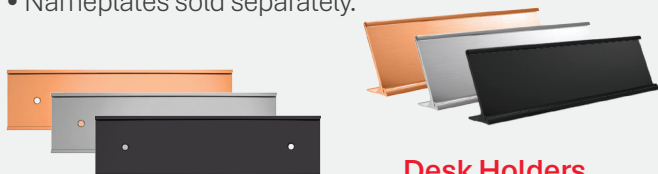

Wall Holders

Part #	Size	Price
2908-3	1 x 8 x 1/16"	\$10.40
2910-4	1 x 10 x 1/16"	\$11.10
2908-5	1-1/2 x 8 x 1-1/16"	\$10.40
2910-6	1-1/2 x 10 x 1-1/16"	\$11.10
3008-3*	2 x 8 x 1/16"	\$10.40
3010-4*	2 x 10 x 1/16"	\$11.10

* Available in gold tone, silver finish, or black

Desk Holders

Part #	Size	Price
1008-4*	2 x 8 x 1/16"	\$17.40
1010-5*	2 x 10 x 1/16"	\$19.85

* Available in gold tone, silver finish, or black

T-Style Holder

Part #	Size	Price
2602-1	2-1/2 x any 1/8"	\$12.60
2604-2	4 x any 1/8"	\$13.95

Nameplate Backing

- For 8" or 10" nameplates.
- Backing is applied to the nameplate or sold separately

Part #	Size	Description	Price
SP2	n/a	Sign Pin Set of 2	\$6.65
A1	n/a	Adhesive	\$1.75
V1	n/a	Velcro	\$2.25
M2	n/a	Magnetic Tape	\$2.10
SDS	n/a	Stax Desk Stand	\$3.05
CPH	n/a	Cubicle Hanger	\$9.60

* Available in gold tone, silver finish, or black

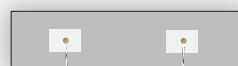

SP2

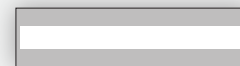

A1

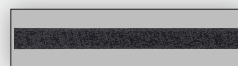

M2

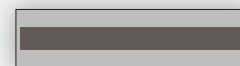

V1



SDS



CPH

CUSTOM SIZE SIGNS

Engraved Plastic or Aluminum

- Square corners are standard

Quantity Discounts			
10%	20%	25%	30%
10-24	25-49	50-99	100+

Custom Engraved Plastic Signs

1/16" thickness and includes 3 lines of copy. Mounted with adhesive, holes, or velcro requested at the time of order. For 2-sided 1/8" thickness sign add 50%. Add \$3/line for additional copy.

- Part # is 212.

Sq.In	Price (1-9)	Sq.In	Price (1-9)	Sq.In	Price (1-9)
1-5	\$16.65	51-60	\$30.50	111-120	\$46.25
6-10	\$18.15	61-70	\$33.20	121-130	\$48.95
11-20	\$20.25	71-80	\$35.85	131-140	\$51.70
21-30	\$22.75	81-90	\$38.60	141-150	\$54.30
31-40	\$25.45	91-100	\$41.30	151-160	\$57.15
41-50	\$27.80	101-110	\$43.95	161-170	\$59.75

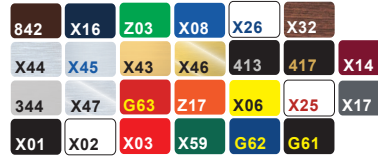

Additional Customizations

Part #	Description	Price
BRaille	Add Braille (per sign)	\$17.50
ADA	Add ADA Raised Text/Icons (per sign)	\$15.00
LOGO-2	Logo Setup Charge (one time)	\$24.95



Laser Etch on Aluminum NEW

Achieve a sleek, professional look with precision laser etching on aluminum. Perfect for indoor or outdoor use, this method offers striking silver or gold etching on red, black, or blue aluminum, as well as bold black etching on silver or gold Alumamark.

Part #	Description	Thickness	Use
ASBSS	Alumamark Black Etch On Satin Silver	0.02in	Indoor
ASBSG	Alumamark Black Etch On Satin Gold	0.02in	Indoor
LASB	Laser Aluminum Silver Etch On Black	0.04in	Indoor/Outdoor
LASBL	Laser Aluminum Silver Etch On Blue	0.04in	Indoor/Outdoor
LASR	Laser Aluminum Silver Etch On Red	0.04in	Indoor/Outdoor
LAGB	Laser Aluminum Gold Etch On Black	0.04in	Indoor/Outdoor

Full Colour on Aluminum NEW

Bring your designs to life with full-colour printing on durable aluminum. Using a high-quality dye sublimation process, this option is ideal for indoor displays that demand sharp detail and lasting impact.

Part #	Description	Use
213-41	Misc. Dye Sub On White Aluminum	Indoor
213-4B	Misc. Dye Sub On Brushed Brass Aluminum	Indoor
213-4A	Misc. Dye Sub On Brushed Silver Aluminum	Indoor



Size and Price Chart

Sq.In	Price (1-9)	Sq.In	Price (1-9)	Sq.In	Price (1-9)	Sq.In	Price (1-9)
5	\$21.35	30	\$34.05	80	\$55.60	130	\$68.75
10	\$24.45	40	\$39.05	90	\$58.90	140	\$70.40
15	\$26.50	50	\$43.70	100	\$61.90	150	\$71.70
20	\$28.75	60	\$48.00	110	\$64.50	160	\$72.65
25	\$31.35	70	\$52.95	120	\$66.80	170	\$73.25

Additional Charges

Description	Price
Rounded Corners	\$1.00
Drilled Holes	\$1.00

* Supply vector artwork or additional charges will apply
* Additional backing options on page 34



FULL COLOUR VINYL

Custom decals for every purpose imaginable.

- Decals in small or large quantities
- Installation-ready vinyl letters and graphics

Which Material Is Right for You?



Permanent Vinyl Decal

- Durable more permanent option
- Heavy-duty adhesive
- Recommended for long-term use on walls and windows

Adhesive on front or back, laminated for indoor or outdoor use. Minimum order of \$15.00. Call for quotation on orders over 100. For images with white or creamy colours, we recommend printing on white vinyl or printing with isolated white ink.

Removable Vinyl Decal

- Low-tac adhesive removable vinyl
- Great for temporary signage
- Recommended for short-term use on walls and windows

Sticks to glass without adhesive and can be taken off and reapplied without leaving residue. Great for signage you may want to replace. For images with white or creamy colours, we recommend printing on white vinyl or printing with isolated white ink.

Perforated Vinyl Decal

- Evenly spaced holes throughout the vinyl allow for one-way visibility
- Recommended for long-term indoor use or short-term outdoor use on windows

Utilize your window space for advertising without sacrificing natural light or visibility. Those on the inside also benefit from reduced sun glare and increased privacy.

FRONT



BACK



Print Methods on Vinyl

Clear Vinyl with no white ink: Creates a subtle appearance with muted colours that are semitransparent



Full Colour on White Vinyl: Solid, bright vibrant colours with a white back



White Ink on Clear Vinyl: White ink is printed behind the image making colours more vibrant with no translucency. Best on coloured walls or images with white and pastel colours. **Vector art required.**



FRONT

BACK



Permanent Vinyl Decal - Standard Sizes

Clear/White Background Full Colour Design

Part #	Dimensions	1-9	10-24	25-49	50-99
55D	5 x 5"	\$7.35	\$6.62	\$5.88	\$5.15
88D	8 x 8"	\$13.80	\$12.42	\$11.04	\$9.66
1212D	12 x 12"	\$20.20	\$18.18	\$16.16	\$14.14
1218D	12 x 18"	\$27.95	\$25.16	\$22.36	\$19.57
1224D	12 x 24"	\$34.15	\$30.74	\$27.32	\$23.91
1824D	18 x 24"	\$43.50	\$39.15	\$34.80	\$30.45
2436D	24 x 36"	\$63.25	\$56.93	\$50.60	\$44.28

Clear Background With Isolated White

Part #	Dimensions	1-9	10-24	25-49	50-99
55DW	5 x 5"	\$8.45	\$7.61	\$6.76	\$5.92
88DW	8 x 8"	\$15.90	\$14.31	\$12.72	\$11.13
1212DW	12 x 12"	\$21.25	\$19.13	\$17.00	\$14.88
1218DW	12 x 18"	\$29.65	\$26.69	\$23.72	\$20.76
1224DW	12 x 24"	\$36.30	\$32.67	\$29.04	\$25.41
1824DW	18 x 24"	\$46.75	\$42.08	\$37.40	\$32.73
2436DW	24 x 36"	\$69.70	\$62.73	\$55.76	\$48.79



Removable Vinyl Decal - Standard Sizes

• low tac adhesive

Clear/White Background Full Colour Design

Part #	Dimensions	1-9	10-24	25-49	50-99
55DC	5 x 5"	\$8.45	\$7.61	\$6.76	\$5.92
88DC	8 x 8"	\$15.90	\$14.31	\$12.72	\$11.13
1212DC	12 x 12"	\$23.20	\$20.88	\$18.56	\$16.24
1218DC	12 x 18"	\$32.10	\$28.89	\$25.68	\$22.47
1224DC	12 x 24"	\$39.30	\$35.37	\$31.44	\$27.51
1824DC	18 x 24"	\$50.00	\$45.00	\$40.00	\$35.00
2436DC	24 x 36"	\$72.75	\$65.48	\$58.20	\$50.93

Clear Background With Isolated White

Part #	Dimensions	1-9	10-24	25-49	50-99
55DCW	5 x 5"	\$9.75	\$8.78	\$7.80	\$6.83
88DCW	8 x 8"	\$18.30	\$16.47	\$14.64	\$12.81
1212DCW	12 x 12"	\$24.45	\$22.01	\$19.56	\$17.12
1218DCW	12 x 18"	\$34.00	\$30.60	\$27.20	\$23.80
1224DCW	12 x 24"	\$41.75	\$37.58	\$33.40	\$29.23
1824DCW	18 x 24"	\$53.75	\$48.38	\$43.00	\$37.63
2436DCW	24 x 36"	\$80.15	\$72.14	\$64.12	\$56.11



Perforated Vinyl Decal - Standard Sizes

Part #	Dimensions	1-9	10-24	25-49	50-99
55DPWW	5 x 5"	\$8.45	\$7.61	\$6.76	\$5.92
88DPWW	8 x 8"	\$15.90	\$14.31	\$12.72	\$11.13
1212DPWW	12 x 12"	\$23.20	\$20.88	\$18.56	\$16.24
1218DPWW	12 x 18"	\$32.10	\$28.89	\$25.68	\$22.47
1224DPWW	12 x 24"	\$39.30	\$35.37	\$31.44	\$27.51
1824DPWW	18 x 24"	\$50.00	\$45.00	\$40.00	\$35.00
2436DPWW	24 x 36"	\$72.75	\$65.48	\$58.20	\$50.93

Additional Services

Available for all vinyl types.

Part #	Description	Price
CCS	Contour Cut Set Up Charge	\$15.00
SETUPW	White Set Up Charge	\$15.00

Full Colour Vinyl

Vinyl Custom Sizes



Permanent Vinyl Decal - Custom Sizes

Clear or White Background with Full Colour (no white Ink)

Part #243D

Sq. In.	1-9	10-24	25-49	50-99
5	\$3.70	\$3.33	\$2.96	\$2.59
10	\$4.80	\$4.32	\$3.84	\$3.36
15	\$5.90	\$5.31	\$4.72	\$4.13
20	\$6.60	\$5.94	\$5.28	\$4.62
25	\$7.35	\$6.62	\$5.88	\$5.15
30	\$8.05	\$7.25	\$6.44	\$5.64
40	\$9.80	\$8.82	\$7.84	\$6.86
50	\$11.30	\$10.17	\$9.04	\$7.91
60	\$13.05	\$11.75	\$10.44	\$9.14
70	\$13.80	\$12.42	\$11.04	\$9.66
80	\$15.70	\$14.13	\$12.56	\$10.99
90	\$16.00	\$14.40	\$12.80	\$11.20
100	\$17.25	\$15.53	\$13.80	\$12.08
110	\$17.70	\$15.93	\$14.16	\$12.39
120	\$19.10	\$17.19	\$15.28	\$13.37
130	\$19.45	\$17.51	\$15.56	\$13.62
1 Sq Ft	\$20.20	\$18.18	\$16.16	\$14.14
2 Sq Ft	\$34.15	\$30.74	\$27.32	\$23.91
3 Sq Ft	\$43.50	\$39.15	\$34.80	\$30.45
4 Sq Ft	\$52.25	\$47.03	\$41.80	\$36.58
5 Sq Ft	\$58.60	\$52.74	\$46.88	\$41.02
6 Sq Ft	\$63.25	\$56.93	\$50.60	\$44.28
7+ Sq Ft	\$9.50*	\$8.55*	\$7.60*	\$6.65*

* Price per Sq Ft

CCS Contour Cut Setup Charge \$15.00

Permanent Vinyl Decal with White Ink - Custom Sizes

Clear Background with Isolated White

Part #243DW

Sq. In.	1-9	10-24	25-49	50-99
5	\$4.25	\$3.83	\$3.40	\$2.98
10	\$5.55	\$5.00	\$4.44	\$3.89
15	\$6.80	\$6.12	\$5.44	\$4.76
20	\$7.60	\$6.84	\$6.08	\$5.32
25	\$8.45	\$7.61	\$6.76	\$5.92
30	\$9.30	\$8.37	\$7.44	\$6.51
40	\$11.30	\$10.17	\$9.04	\$7.91
50	\$13.00	\$11.70	\$10.40	\$9.10
60	\$15.05	\$13.55	\$12.04	\$10.54
70	\$15.90	\$14.31	\$12.72	\$11.13
80	\$17.85	\$16.07	\$14.28	\$12.50
90	\$18.05	\$16.25	\$14.44	\$12.64
100	\$18.85	\$16.97	\$15.08	\$13.20
110	\$19.25	\$17.33	\$15.40	\$13.48
120	\$20.60	\$18.54	\$16.48	\$14.42
130	\$20.95	\$18.86	\$16.76	\$14.67
1 Sq Ft	\$21.25	\$19.13	\$17.00	\$14.88
2 Sq Ft	\$36.30	\$32.67	\$29.04	\$25.41
3 Sq Ft	\$46.75	\$42.08	\$37.40	\$32.73
4 Sq Ft	\$56.50	\$50.85	\$45.20	\$39.55
5 Sq Ft	\$63.95	\$57.56	\$51.16	\$44.77
6 Sq Ft	\$69.70	\$62.73	\$55.76	\$48.79
7+ Sq Ft	\$10.55*	\$9.50*	\$8.44*	\$7.39*

* Price per Sq Ft

CCS Contour Cut Setup Charge \$15.00

SETUPW White Setup Charge \$15.00

Removable Vinyl Decal - Custom Sizes

Clear Background With Isolated White Ink

• Low tac adhesive

• White Ink: Part #243DCW

Sq. In.	1-9	10-24	25-49	50-99
5	\$4.90	\$4.41	\$3.92	\$3.43
10	\$6.35	\$5.72	\$5.08	\$4.45
15	\$7.85	\$7.07	\$6.28	\$5.50
20	\$8.75	\$7.88	\$7.00	\$6.13
25	\$9.75	\$8.78	\$7.80	\$6.83
30	\$10.65	\$9.59	\$8.52	\$7.46
40	\$13.00	\$11.70	\$10.40	\$9.10
50	\$14.95	\$13.46	\$11.96	\$10.47
60	\$17.30	\$15.57	\$13.84	\$12.11
70	\$18.30	\$16.47	\$14.64	\$12.81
80	\$20.50	\$18.45	\$16.40	\$14.35
90	\$20.75	\$18.68	\$16.60	\$14.53
100	\$21.70	\$19.53	\$17.36	\$15.19
110	\$22.10	\$19.89	\$17.68	\$15.47
120	\$23.70	\$21.33	\$18.96	\$16.59
130	\$24.10	\$21.69	\$19.28	\$16.87
1 Sq Ft	\$24.45	\$22.01	\$19.56	\$17.12
2 Sq Ft	\$41.75	\$37.58	\$33.40	\$29.23
3 Sq Ft	\$53.75	\$48.38	\$43.00	\$37.63
4 Sq Ft	\$65.00	\$58.50	\$52.00	\$45.50
5 Sq Ft	\$73.55	\$66.20	\$58.84	\$51.49
6 Sq Ft	\$80.15	\$72.14	\$64.12	\$56.11
7+ Sq Ft	\$12.05*	\$10.85*	\$9.64*	\$8.44*

* Price per Sq Ft

CCS	Contour Cut Setup Charge	\$15.00
SETUPW	White Setup Charge	\$15.00

Perforated Vinyl Decal - Custom Sizes

Clear/White Background Full Colour Design

Part #243DPWW

Size (sq in)	1-9	10-24	25-49	50-99
5	\$4.25	\$3.83	\$3.40	\$2.98
10	\$5.50	\$4.95	\$4.40	\$3.85
15	\$6.80	\$6.12	\$5.44	\$4.76
20	\$7.60	\$6.84	\$6.08	\$5.32
25	\$8.45	\$7.61	\$6.76	\$5.92
30	\$9.25	\$8.33	\$7.40	\$6.48
40	\$11.30	\$10.17	\$9.04	\$7.91
50	\$13.00	\$11.70	\$10.40	\$9.10
60	\$15.00	\$13.50	\$12.00	\$10.50
70	\$15.90	\$14.31	\$12.72	\$11.13
80	\$18.05	\$16.25	\$14.44	\$12.64
90	\$18.40	\$16.56	\$14.72	\$12.88
100	\$19.85	\$17.87	\$15.88	\$13.90
110	\$20.30	\$18.27	\$16.24	\$14.21
120	\$22.00	\$19.80	\$17.60	\$15.40
130	\$22.35	\$20.12	\$17.88	\$15.65
1 Sq Ft	\$23.20	\$20.88	\$18.56	\$16.24
2 Sq Ft	\$39.25	\$35.33	\$31.40	\$27.48
3 Sq Ft	\$50.00	\$45.00	\$40.00	\$35.00
4 Sq Ft	\$60.05	\$54.04	\$48.04	\$42.04
5 Sq Ft	\$67.40	\$60.66	\$53.92	\$47.18
6 Sq Ft	\$72.75	\$65.48	\$58.20	\$50.93
7+ Sq Ft	\$10.90*	\$9.81*	\$8.72*	\$7.63*

* Price per Sq Ft

CCS	Contour Cut Setup Charge	\$15.00
-----	--------------------------	---------

Removable Vinyl Decal - Custom Sizes

Clear/White Background Full Colour Design

Part #243DC

Sq. In.	1-9	10-24	25-49	50-99
5	\$4.25	\$3.83	\$3.40	\$2.98
10	\$5.50	\$4.95	\$4.40	\$3.85
15	\$6.80	\$6.12	\$5.44	\$4.76
20	\$7.60	\$6.84	\$6.08	\$5.32
25	\$8.45	\$7.61	\$6.76	\$5.92
30	\$9.25	\$8.33	\$7.40	\$6.48
40	\$11.30	\$10.17	\$9.04	\$7.91
50	\$13.00	\$11.70	\$10.40	\$9.10
60	\$15.00	\$13.50	\$12.00	\$10.50
70	\$15.90	\$14.31	\$12.72	\$11.13
80	\$18.05	\$16.25	\$14.44	\$12.64
90	\$18.40	\$16.56	\$14.72	\$12.88
100	\$19.85	\$17.87	\$15.88	\$13.90
110	\$20.30	\$18.27	\$16.24	\$14.21
120	\$22.00	\$19.80	\$17.60	\$15.40
130	\$22.35	\$20.12	\$17.88	\$15.65
1 Sq Ft	\$23.20	\$20.88	\$18.56	\$16.24
2 Sq Ft	\$39.25	\$35.33	\$31.40	\$27.48
3 Sq Ft	\$50.00	\$45.00	\$40.00	\$35.00
4 Sq Ft	\$60.05	\$54.05	\$48.04	\$42.04
5 Sq Ft	\$67.40	\$60.66	\$53.92	\$47.18
6 Sq Ft	\$72.75	\$65.48	\$58.20	\$50.93
7+ Sq Ft	\$10.90*	\$9.81*	\$8.72*	\$7.63*

* Price per Sq Ft

CCS	Contour Cut Setup Charge	\$15.00
-----	--------------------------	---------



Vinyl Custom



KISS CUT VINYL DECALS & FLOOR AND CARPET DECALS

Kiss-cut Vinyl

Perfect for large graphics displayed on glass or walls. Ideal for 1 or 2 colour designs without a lot of detail. Offers vibrant, bold, opaque colours. **One colour pricing only - for each additional colour add 25%.** Vector art required, or additional design charges may apply. Standard stock vinyl colours only. Any special colours or specialty vinyl are custom quoted. **Part #212V**

Sq. In.	1-9	10-24	25-49	50-99
5	\$6.10	\$5.49	\$4.88	\$4.58
10	\$7.00	\$6.30	\$5.60	\$5.25
15	\$7.90	\$7.11	\$6.32	\$5.93
20	\$8.80	\$7.92	\$7.04	\$6.60
25	\$9.70	\$8.73	\$7.76	\$7.28
30	\$10.60	\$9.54	\$8.48	\$7.95
40	\$12.35	\$11.12	\$9.88	\$9.26
50	\$14.15	\$12.74	\$11.32	\$10.61
60	\$15.95	\$14.36	\$12.76	\$11.96
70	\$17.75	\$15.98	\$14.20	\$13.31
80	\$19.55	\$17.60	\$15.64	\$14.66
90	\$21.35	\$19.22	\$17.08	\$16.01
100	\$23.15	\$20.84	\$18.52	\$17.36
110	\$24.95	\$22.46	\$19.96	\$18.71
120	\$26.70	\$24.03	\$21.36	\$20.03
130	\$28.50	\$25.65	\$22.80	\$21.38
1 Sq Ft	\$29.85	\$26.87	\$23.88	\$22.39
2 Sq Ft	\$51.75	\$46.58	\$41.40	\$38.81
3 Sq Ft	\$65.65	\$59.09	\$52.52	\$49.24
4 Sq Ft	\$79.50	\$71.55	\$63.60	\$59.63
5 Sq Ft	\$89.40	\$80.46	\$71.52	\$67.05
6 Sq Ft	\$95.25	\$85.73	\$76.20	\$71.44
7+ Sq Ft	\$14.25/sqft	\$12.83/sqft	\$11.40/sqft	\$10.69/sqft



Floor Vinyl

Floor & Carpet Decals Standard Shapes and Sizes

Peel and stick removable floor decals! Made of quality 8 mil thick vinyl for durability. Easy to install, care for, and remove. Indoor use on hard flooring only.

Floor Decals

Shape	Size	Part #	1-9	10-24	25-49	50-99
Square	12 x 12"	FD1212	\$25.25	\$22.70	\$20.20	\$17.68
Rectangle	12 x 18"	FD1218	\$32.05	\$28.80	\$25.64	\$22.44
Circle	12" diam.	FD1212C	\$25.25	\$22.70	\$20.20	\$17.68
Arrow	8 x 18"	FD818	\$25.25	\$22.70	\$20.20	\$17.68

Carpet Decals

Shape	Size	Part #	1-9	10-24	25-49	50-99
Square	12 x 12"	FDC1212	\$28.45	\$25.90	\$22.76	\$19.92
Rectangle	12 x 18"	FDC1218	\$36.85	\$33.65	\$29.48	\$25.80
Circle	12" diam.	FDC1212C	\$28.45	\$25.90	\$22.76	\$19.92
Arrow	8 x 18"	FDC818	\$28.45	\$25.90	\$22.76	\$19.92

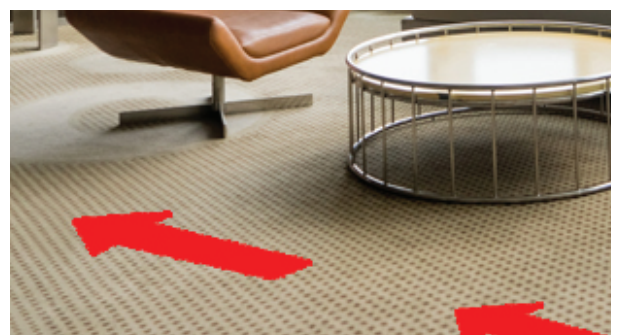



Floor Vinyl Decal

- Custom peel and stick removable Floor Decals!
- Recommended for up to 6 months to ensure easy removability

Made of quality 8 mil thick vinyl for durability. Water and slip resistant floor decals are easy to install, care for, and remove. Indoor use only on a smooth flooring surface including ceramic, smooth concrete, marble, vinyl, and wood. Part #FDM

Sq. In.	1-9	10-24	25-49	50-99
5	\$4.65	\$4.19	\$3.72	\$3.26
10	\$5.95	\$5.36	\$4.76	\$4.17
15	\$7.40	\$6.66	\$5.92	\$5.18
20	\$8.25	\$7.43	\$6.60	\$5.78
25	\$9.20	\$8.28	\$7.36	\$6.44
30	\$10.05	\$9.05	\$8.04	\$7.04
40	\$12.25	\$11.03	\$9.80	\$8.58
50	\$14.15	\$12.74	\$11.32	\$9.91
60	\$16.35	\$14.72	\$13.08	\$11.45
70	\$17.25	\$15.53	\$13.80	\$12.08
80	\$19.60	\$17.64	\$15.68	\$13.72
90	\$20.00	\$18.00	\$16.00	\$14.00
100	\$21.55	\$19.40	\$17.24	\$15.09
110	\$22.10	\$19.89	\$17.68	\$15.47
120	\$23.90	\$21.51	\$19.12	\$16.73
130	\$24.30	\$21.87	\$19.44	\$17.01
1 Sq Ft	\$25.25	\$22.73	\$20.20	\$17.68
2 Sq Ft	\$42.70	\$38.43	\$34.16	\$29.89
3 Sq Ft	\$54.40	\$48.96	\$43.52	\$38.08
4 Sq Ft	\$65.30	\$58.77	\$52.24	\$45.17
5 Sq Ft	\$73.25	\$65.93	\$58.60	\$51.28
6 Sq Ft	\$79.05	\$71.15	\$63.24	\$55.34
7+ Sq Ft	\$11.85/Sq Ft	\$10.67/Sq Ft	\$9.48/Sq Ft	\$8.30/Sq Ft

CCS Contour Cut Setup Charge \$15.00

Carpet Vinyl Decal

- Custom peel and stick removable Carpet Decals!
- Recommended for up to 6 months to ensure easy removability

Made of quality 6 mil fabric with removable high tack adhesive. Water and slip resistant carpet decals are easy to install, care for, and remove. Indoor use only on virtually any flooring surface including carpet, tile, ceramic, smooth concrete, marble, vinyl, and wood. Part #CDM

Sq. In.	1-9	10-24	25-49	50-99
5	\$4.75	\$4.28	\$3.80	\$3.33
10	\$6.20	\$5.58	\$4.96	\$4.34
15	\$7.70	\$6.93	\$6.16	\$5.39
20	\$8.70	\$7.83	\$6.96	\$6.09
25	\$9.75	\$8.78	\$7.80	\$6.83
30	\$10.70	\$9.63	\$8.56	\$7.49
40	\$13.15	\$11.84	\$10.52	\$9.21
50	\$15.25	\$13.73	\$12.20	\$10.68
60	\$17.70	\$15.93	\$14.16	\$12.39
70	\$18.85	\$16.97	\$15.08	\$13.20
80	\$21.40	\$19.26	\$17.12	\$14.98
90	\$22.00	\$19.80	\$17.60	\$15.40
100	\$23.80	\$21.42	\$19.04	\$16.66
110	\$24.55	\$22.10	\$19.64	\$17.19
120	\$26.55	\$23.90	\$21.24	\$18.56
130	\$27.20	\$24.48	\$21.76	\$19.04
1 Sq Ft	\$28.45	\$25.61	\$22.76	\$19.92
2 Sq Ft	\$49.10	\$44.91	\$39.28	\$34.37
3 Sq Ft	\$64.00	\$57.60	\$51.20	\$44.80
4 Sq Ft	\$78.15	\$70.34	\$62.52	\$54.71
5 Sq Ft	\$89.30	\$80.37	\$71.44	\$62.51
6 Sq Ft	\$98.35	\$88.52	\$78.68	\$68.85
7+ Sq Ft	\$14.55/Sq Ft	\$13.10/Sq Ft	\$11.64/Sq Ft	\$10.19/Sq Ft

CCS Contour Cut Setup Charge \$15.00

Floor Vinyl



FULL COLOUR SIGNAGE

Full colour graphics printed directly onto the material

0.020" Styrene (page 44)

1/8" PVC (below)

1/8" Coroplast (page 46)

1/8" Clear Acrylic (page 43)

1/8" Dibond (below)

Dibond Signs

Indoor/Outdoor use, easy to clean, extremely lightweight, rigid, and durable. Aluminum outer with polyethylene core. White is the best option for outdoor use. Call for a quote for brushed silver or other colour backgrounds. Double Sided add 25%. Holes or adhesive back is included but must be specified at the time of order.

Part #	Size	1-9	10-24	25-49	50-99	100+
DD1212	12 x 12"	\$40.10	\$36.09	\$32.08	\$30.08	\$28.07
DD1218	12 x 18"	\$53.45	\$48.11	\$42.76	\$40.09	\$37.42
DD1224	12 x 24"	\$63.10	\$56.79	\$50.48	\$47.33	\$44.17
DD1824	18 x 24"	\$79.65	\$71.69	\$63.72	\$59.74	\$55.76
DD2424	24 x 24"	\$97.35	\$87.62	\$77.88	\$73.01	\$68.15
DD2228	22 x 28"	\$100.75	\$90.68	\$80.60	\$75.56	\$70.53
DD2436	24 x 36"	\$122.35	\$110.12	\$97.88	\$91.76	\$85.65
DD3236	32 x 36"	\$147.95	\$133.16	\$118.36	\$110.96	\$103.57
DD3248	32 x 48"	\$152.75	\$137.48	\$122.20	\$114.56	\$106.93
DD3636	36 x 36"	\$181.85	\$163.67	\$145.48	\$136.39	\$127.30
DD3648	36 x 48"	\$202.75	\$182.48	\$162.20	\$152.06	\$141.93
DD4848	48 x 48"	\$207.25	\$186.53	\$165.80	\$155.44	\$145.08
DDM	Custom sizes over 17sq.ft.		\$12.80/ sq.ft			
CCS	Custom Cut Setup Charge		\$15.00			



Laminate	1-4 sq.ft	5-9 sq.ft	9+ sq.ft
Matte	\$3.50/sq.ft	\$2.95/sq.ft	\$2.45/sq.ft
Gloss	\$3.50/sq.ft	\$2.95/sq.ft	\$2.45/sq.ft
Dry Erase*	\$5.10/sq.ft	\$4.15/sq.ft	\$3.20/sq.ft

*Turn your sign into a dry erase whiteboard

PVC Signs

Indoor/Outdoor smooth material, easy to clean, durable and rigid. Double Sided add 25%. Holes or adhesive back is included but must be specified at the time of order.

Part #	Size	1-2	3-5	6-10	11-29	30-49	50+
DV1212	12" x 12"	\$30.35	\$27.32	\$24.28	\$21.25	\$18.21	\$15.18
DV1218	12" x 18"	\$41.00	\$34.85	\$30.75	\$26.65	\$22.55	\$18.45
DV1224	12" x 24"	\$48.55	\$38.84	\$33.99	\$29.13	\$24.28	\$19.42
DV1824	18" x 24"	\$63.75	\$47.81	\$41.44	\$35.06	\$28.69	\$22.31
DV2424	24" X 24"	\$77.95	\$58.46	\$50.67	\$42.87	\$35.08	\$27.28
DV2228	22" x 28"	\$81.10	\$60.83	\$52.72	\$44.61	\$36.50	\$28.39
DV2436	24" x 36"	\$96.65	\$72.49	\$62.82	\$53.16	\$43.49	\$33.83
DV3236	32" x 36"	\$121.70	\$91.28	\$79.11	\$66.94	\$54.77	\$42.60
DV3248	32" x 48"	\$124.40	\$93.30	\$80.86	\$68.42	\$55.98	\$43.54
DV3636	36" x 36"	\$152.00	\$114.00	\$98.80	\$83.60	\$68.40	\$53.20
DV3648	36" x 48"	\$158.90	\$119.18	\$103.29	\$87.40	\$71.51	\$55.62
DV4848	48" x 48"	\$161.50	\$121.13	\$104.98	\$88.83	\$72.68	\$56.53
DV4896	48" x 96"	\$230.00	\$172.50	\$149.50	\$126.50	\$103.50	\$80.50
DVM	Custom sizes over 17 sq/ft		\$10.05/ sq.ft				
CCS	Contour Cut Setup Charge		\$15.00				



Acrylic Signs

Indoor/Outdoor use, durable, rigid, and tamper resistant. Graphics are printed subsurface to protect them. Double Sided add 25%. Holes or adhesive back is included but must be specified at the time of order.



A

A) Full colour on white background for a completely solid design



C

C) Full colour design is backed in isolated white for solid colours on clear acrylic (Vector art required or additional design charges may apply)



B

B) Full colour on clear acrylic with none of the design backed in white for a semi-translucent design

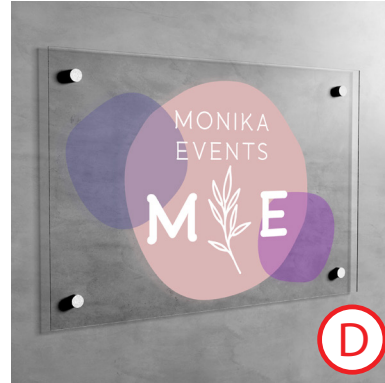

D

D) Centre of the design is backed in white making that area solid. Areas not backed in white are semi-translucent. (Vector art required or additional design charges may apply)

ACRYLIC SIGNS ARE GREAT FOR DRY ERASE!
NO LAMINATE NEEDED, JUST WRITE WITH A DRY ERASE MARKER AND WIPE CLEAN.

Solid Image (A & B)

Part #	Size	1-9	10-24	25-49	50-99	100+
DA1212	12 x 12"	\$42.75	\$38.48	\$34.20	\$32.06	\$29.93
DA1218	12 x 18"	\$57.75	\$51.98	\$46.20	\$43.31	\$40.43
DA1224	12 x 24"	\$68.45	\$61.61	\$54.76	\$51.34	\$47.92
DA1824	18 x 24"	\$89.90	\$80.82	\$71.84	\$67.35	\$62.86
DA2424	24 x 24"	\$109.70	\$98.73	\$87.76	\$82.28	\$76.79
DA2228	22 x 28"	\$114.35	\$102.92	\$91.48	\$85.76	\$80.05
DA2436	24 x 36"	\$136.95	\$123.26	\$109.56	\$102.71	\$95.87
DA3236	32 x 36"	\$176.75	\$159.08	\$141.40	\$132.56	\$123.73
DA3248	32 x 48"	\$181.55	\$163.40	\$145.24	\$136.16	\$127.09
DA3636	36 x 36"	\$217.85	\$196.07	\$174.28	\$163.39	\$152.50
DA3648	36 x 48"	\$242.85	\$218.57	\$194.28	\$182.14	\$170.00
DA4848	48 x 48"	\$250.25	\$225.23	\$200.20	\$187.69	\$175.18
DAM	Custom sizes over 17 sq/ft	\$15.45/ sq.ft				
CCS	Custom Cut Setup Charge	\$15.00				

Translucent and clear backgrounds with isolated solid colour areas (C & D)

Effect created by printing isolated white behind image. Vector art required or additional design charges may apply.

Part #	Size	1-9	10-24	25-49	50-99	100+
DA1212W	12 x 12"	\$49.95	\$44.96	\$39.96	\$37.46	\$34.97
DA1218W	12 x 18"	\$65.95	\$59.36	\$52.76	\$49.46	\$46.17
DA1224W	12 x 24"	\$77.55	\$69.80	\$62.04	\$58.16	\$54.29
DA1824W	18 x 24"	\$100.75	\$90.68	\$80.60	\$75.56	\$70.53
DA2424W	24 x 24"	\$122.55	\$110.30	\$98.04	\$91.91	\$85.79
DA2228W	22 x 28"	\$127.70	\$114.93	\$102.16	\$95.78	\$89.39
DA2436W	24 x 36"	\$153.40	\$138.06	\$122.72	\$115.05	\$107.38
DA3236W	32 x 36"	\$196.10	\$176.49	\$156.88	\$147.08	\$137.27
DA3248W	32 x 48"	\$200.90	\$180.81	\$160.72	\$150.68	\$140.63
DA3636W	36 x 36"	\$244.20	\$219.78	\$195.36	\$183.15	\$170.94
DA3648W	36 x 48"	\$270.60	\$243.54	\$216.48	\$202.95	\$189.42
DA4848W	48 x 48"	\$285.55	\$257.00	\$228.44	\$214.16	\$199.89
DAMW	Custom sizes over 17 sq/ft	\$17.85/sq.ft				
CCS	Custom Cut Setup Charge	\$15.00				
SETUPW	White Setup Charge	\$15.00				

Full Colour Signage

Satin Stainless Steel Standoffs

Mount your sign off of the wall to give it that extra pop. Available in 1" and 5/8" diameters and includes all mounting hardware. Holds material 1/8" to 1/4" thick. (see examples above)

Part #	Diameter	Off Wall	Price
SO5834	5/8"	3/4"	\$11.95 ea
SO5834S	5/8"	3/4"	\$47.75/ 4 pack
SO11	1"	1"	\$17.25 ea
SO11S	1"	1"	\$68.95/ 4 pack



Decorative Screw Covers

Stainless steel finish metal cap is secured with threads for extra stability. Includes all mounting hardware.

Part #	Description	Price
SC58S	5/8" dia Stainless Steel Screw Cover (set of 4)	\$37.55
SC1S	1" dia Stainless Steel Screw Cover (set of 4)	\$52.95



Quantity Discounts			
10%	20%	25%	30%
10-24	25-49	50-99	100+

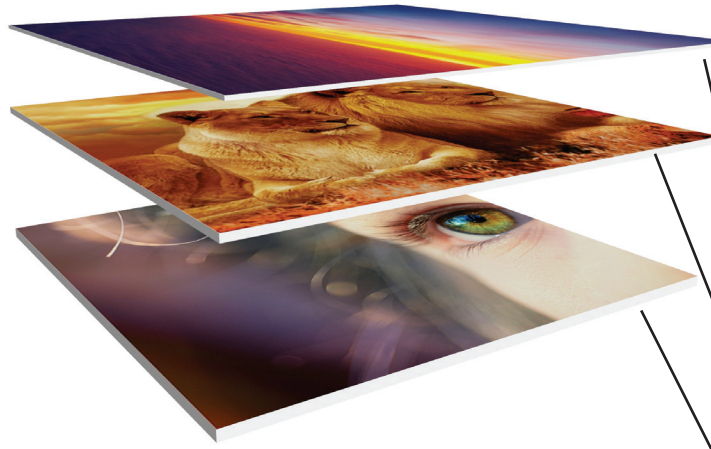

STYRENE PLASTIC POSTERS

Great for displays, promotions, interior or exterior signage, trade shows, and sidewalk sales.

- Full colour graphics printed directly onto the material

0.020" Styrene

A great alternative to posters as they are much more durable and last longer without requiring laminate. They can be rolled up and then mounted directly on a wall or inserted into a poster frame.

0.040" Styrene

Perfect for displays, small more permanent signage or special applications like parking tags to hang on rear view mirrors. This thickness stays flat while still maintaining some flexibility.

0.060" Styrene

Permanent signage with a nicer finish and lower profile than Coroplast and PVC while maintaining a comparable amount of rigidity. Can also be used for large volume low cost name badges and other unique applications.

Laminate	1-4 sq.ft	5-9 sq.ft	9+ sq.ft
Matte	\$3.50/sq.ft	\$2.95/sq.ft	\$2.45/sq.ft
Gloss	\$3.50/sq.ft	\$2.95/sq.ft	\$2.45/sq.ft
Dry Erase*	\$5.10/sq.ft	\$4.15/sq.ft	\$3.20/sq.ft

Quantity Discounts			
20%	30%	40%	45%
10-24	25-49	50-99	100+

*Turn your sign into a dry erase whiteboard

Styrene Plastic Posters

Lightweight, durable, flexible and easily transportable. Smooth bright white finish that is suitable for indoor and outdoor use. Double Sided add 25%. Holes or adhesive back is included but must be specified at the time of order.

0.020" Thick

Part #	Size	Price
DS21212	12" x 12"	\$21.35
DS21218	12" x 18"	\$27.80
DS21224	12" x 24"	\$34.20
DS21824	18" x 24"	\$51.35
DS22424	24" x 24"	\$67.80
DS22228	22" x 28"	\$72.10
DS22436	24" x 36"	\$85.55
DS23236	32" x 36"	\$104.30
DS23248	32" x 48"	\$106.95
DS23636	36" x 36"	\$128.35
DS23648	36" x 48"	\$131.05
DS24848	48" x 48"	\$133.70
Custom 0.020" sizes over 17sq/ft.		
DS2M	Custom	\$8.30/sq ft
Contour Cut Setup Charge		
CCS	Custom	\$15.00

0.040" Thick

Part #	Size	Price
DS41212	12" x 12"	\$25.85
DS41218	12" x 18"	\$34.40
DS41224	12" x 24"	\$41.40
DS41824	18" x 24"	\$57.55
DS42424	24" x 24"	\$72.95
DS42228	22" x 28"	\$76.60
DS42436	24" x 36"	\$91.15
DS43236	32" x 36"	\$113.00
DS43248	32" x 48"	\$115.70
DS43636	36" x 36"	\$140.20
DS43648	36" x 48"	\$144.95
DS44848	48" x 48"	\$147.65
Custom 0.040" sizes over 17sq/ft.		
DS4M	Custom	\$9.20/sq ft
Contour Cut Setup Charge		
CCS	Custom	\$15.00

0.060" Thick

Part #	Size	Price
DS61212	12" x 12"	\$30.35
DS61218	12" x 18"	\$40.95
DS61224	12" x 24"	\$48.55
DS61824	18" x 24"	\$63.70
DS62424	24" x 24"	\$77.95
DS62228	22" x 28"	\$81.10
DS62436	24" x 36"	\$96.65
DS63236	32" x 36"	\$121.75
DS63248	32" x 48"	\$124.40
DS63636	36" x 36"	\$152.00
DS63648	36" x 48"	\$158.90
DS64848	48" x 48"	\$161.55
Custom 0.060" sizes over 17sq/ft.		
DS6M	Custom	\$10.05/sq ft
Contour Cut Setup Charge		
CCS	Custom	\$15.00

Styrene Signs





VEHICLE WRAPS & MAGNETIC SIGNAGE

Great for promoting your business or following regulations.

Vinyl Car Wrap

Advertise your business on the body of your vehicle. Suitable for highway speeds. Windows are covered with perforated vinyl to maintain visibility from the inside. See example below Call us for a quote!

Long Combination Vehicle (LCV) Signs



High intensity yellow reflective vinyl. Quantity breaks non-applicable. Aluminum LCV signs are hinged in the centre to allow for them to be folded and kept in the truck cabin when not in use.

Part #	Description	Size	Price
LCV-1296	Reflective black icon and lettering heavy duty centre hinge	12 x 96" x 0.081" thick aluminum	\$335.50
LCV-1296NR	Standard black icon and lettering heavy duty centre hinge	12 x 96" x 0.081" thick aluminum	\$297.00
LCV-1296NRB	Standard black icon and lettering with 8 grommets	12 x 96" 18oz heavy duty banner material	\$192.50
LCV-1396	Reflective black icon and lettering 1/2" diamond grade red/white conspicuity tape border, heavy duty centre hinge	13 x 96" x 0.081" thick aluminum	\$429.00



Magnetic Decals

Great for promotional pieces or special occasions. 15 mil thickness.

Part #	Size	1-9	10-24	25-49	50-99
MS352	3.5 x 2"	\$4.80	\$4.32	\$3.84	\$3.36
MS554	5.5 x 4"	\$8.55	\$7.70	\$6.84	\$5.99
CCS	Custom Cut Setup Charge		\$15.00		

Pricing for other sizes available on page 38 by referring to the Permanent Decals on Clear or White Vinyl price chart and adding 30% to prices listed. **Part #MSM**



Magnetic Car Signs

The flexibility to use your personal vehicle for work without having permanent letters on it. Suitable for highway speeds. Remove before car wash. 30 mil thickness.

Part #	Size	Price for Pair	Single Price
MS524	5 x 24"	\$87.00/pair	\$56.70 ea MS524S
MS824	8 x 24"	\$101.30/pair	\$65.85 ea MS824S
MS1224	12 x 24"	\$115.95/pair	\$72.15 ea MS1224S
MS1824	18 x 24"	\$159.40/pair	\$93.55 ea MS1824S



Magnetic Signs

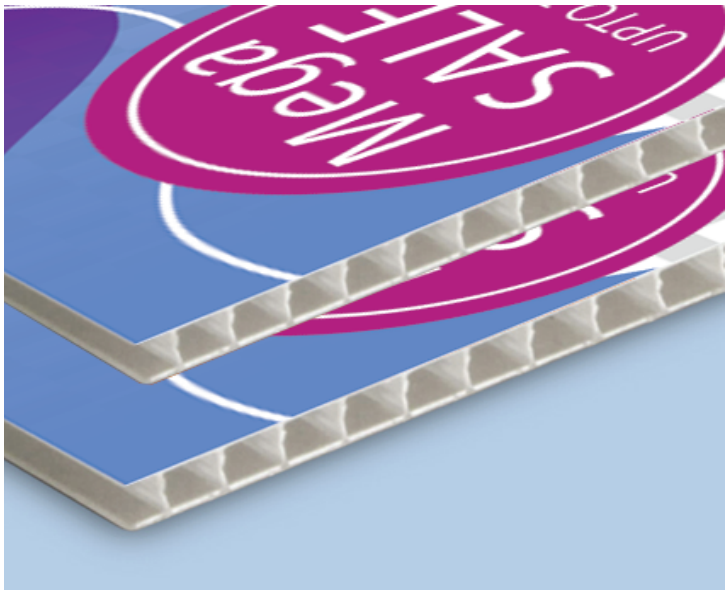

COROPLAST/ LAWN SIGNS

Great for sales, election signs, brand recognition, realtors, or directions to help new customers find you!



Coroplast Signs - without Holders F

Indoor/Outdoor Lightweight plastic, slightly corrugated ridges, 1/8" thick, outdoor use 3-12 months. Frame holders and Step Stakes sold separately. Double Sided add 25%. Holes or adhesive back is included but must be specified at the time of order.

Part #	Size	1-2	3-5	6-10	11-29	30-49	50+
DC1212	12" x 12"	\$21.35	\$19.22	\$17.08	\$14.95	\$12.81	\$10.68
DC1218	12" x 18"	\$27.80	\$23.63	\$20.85	\$18.07	\$15.29	\$12.51
DC1224	12" x 24"	\$34.20	\$27.36	\$23.94	\$20.52	\$17.10	\$13.68
DC1824	18" x 24"	\$51.30	\$38.48	\$33.35	\$28.22	\$23.09	\$17.96
DC2424	24" x 24"	\$67.80	\$50.85	\$44.07	\$37.29	\$30.51	\$23.73
DC2228	22" x 28"	\$72.10	\$54.08	\$46.87	\$39.66	\$32.45	\$25.24
DC2436	24" x 36"	\$85.55	\$64.16	\$55.61	\$47.05	\$38.50	\$29.94
DC3236	32" x 36"	\$104.30	\$78.23	\$67.80	\$57.37	\$46.94	\$36.51
DC3248	32" x 48"	\$106.95	\$80.21	\$69.52	\$58.52	\$48.13	\$37.43
DC3636	36" x 36"	\$128.35	\$96.26	\$83.43	\$70.59	\$57.36	\$44.92
DC3648	36" x 48"	\$131.00	\$98.25	\$85.15	\$72.05	\$58.95	\$45.85
DC4848	48" x 48"	\$133.70	\$100.28	\$86.91	\$73.54	\$60.17	\$46.80
DC4896	48" x 96"	\$192.55	\$144.41	\$125.16	\$105.90	\$86.65	\$67.39
DCM	Custom sizes over 17 sq/ft	\$8.30/ sq.ft					
CCS	Contour Cut Setup Charge	\$15.00					

Step Stakes - Sign Holders D

Made of rust proof steel for coroplast signs with vertical flute. No hardware needed, simply push into ground with foot and insert into the bottom of coroplast sign. Recommended for signs up to 18" x 24."

Part #	Description	1-2	3-5	6-10	11-29	30-49	50+
040-76	10 x 30" Standard Step Stake with 9 gauge wire	\$3.95	\$3.56	\$3.16	\$2.77	\$2.37	\$1.98
PSS	8 x 26" Plastic Spider Stake with 9 gauge wire top	\$7.40	\$6.66	\$5.92	\$5.18	\$4.44	\$3.70
SS2	10 x 30" Heavy Duty Step Stake, 9 gauge top with 3 gauge bottom	\$10.45	\$9.41	\$8.36	\$7.32	\$6.27	\$5.23

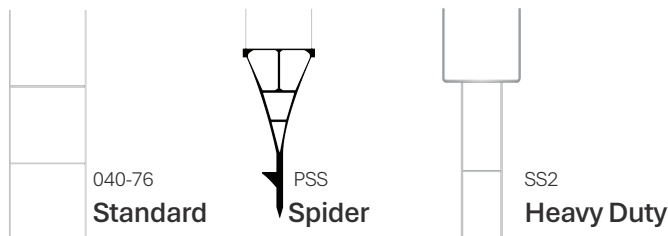

Metal Portrait

Metal Landscape

Deluxe Plastic: Fillable with water or sand for added stability



NEW

A-Frame Holder Bundle with 2 Coroplast Signs F

Save money with a bundle! 2 full colour coroplast signs with 1 black double sided A-frame holder. Great for 2-way traffic. Comes in Metal or Deluxe Plastic made from weather-resistant PE plastic with rust-proof galvanized steel hinges, built to last in any environment.

Material	Part #	Size (W x H)	Description	Price
Metal	S218B	24 x 18"	Landscape	\$146.95
Metal	S203B	24 x 36"	Portrait	\$224.95
Deluxe Plastic	S203PB	24 x 36"	Portrait	\$295.95

NEW

A-Frame Holder Only I

High quality, double sided, sturdy, top loading, and can be used single sign or double sided. Comes in Metal or Deluxe Plastic made from weather-resistant PE plastic with rust-proof galvanized steel hinges, built to last in any environment.

Part #	Part #	Size (W x H)	Description	Price
Metal	S218	24 x 18"	Landscape	\$69.95
Metal	S203	24 x 36"	Portrait	\$96.95
Deluxe Plastic	S203P	24 x 36"	Portrait	\$145.95

RETRACTABLE BANNER STANDS

Professional, Portable, and Easy to Use

- Professional displays with high-quality materials for maximum impact at trade shows, retail spaces, events, and presentations
- Lightweight and portable designs that are easy to assemble and transport for on-the-go marketing
- A variety of styles, sizes, and hardware options to suit different display needs



Deluxe



Premium Banner Stand



Premium

NEW

Premium and Deluxe 33" Retractable Banner Stands

Perfect for trade shows, events, retail spaces, or permanent indoor displays. Comes with an adjustable height and a portable carrying case make setup and transport effortless.

Premium Stand

- Adjustable height from 60" to 82" for versatile display options
- Wide, heavy-duty base for stability on any indoor surface
- Anodized aluminum casing adds strength and durability
- Ideal for trade shows, retail displays, events, and promotions

Deluxe Stand

- Extra low-profile, wide base for superior stability and professional look
- Adjustable height from 60" to 82" to suit your display space
- Deluxe grey hard case for maximum protection during transport
- Perfect for high-traffic events, permanent displays, or portable marketing setups

Part #	Size (WxH)	Description	Price
PR33	33 x 80"	Premium Stand with Banner	\$265.95
DE33	33 x 80"	Deluxe Stand with Banner	\$349.95
BV3380	33 x 80"	Premium or Deluxe Banner Only	\$139.95

Retractor 33" Retractable Banner Stand

Our Retractor Banner Stands are a simple, reliable solution for showcasing your message at trade shows, retail spaces, events, or promotions. Designed for quick setup and easy transport, these stands offer a professional display without the complexity of adjustable systems.

- Fixed height of 79"
- Lightweight anodized aluminum casing with stabilizing feet for added support
- Includes three-part pole for secure setup

Part #	Size (WxH)	Description	Price
RE33	33 x 79"	3 Pole Stand with Banner	\$205.95
BV3379	33 x 79"	Banner Only	\$139.95



Retractor

NEW

X-Banner Stand

Our X-Banner stands provide a cost-effective and versatile way to showcase your message at trade shows, events, retail spaces, or promotional setups. Lightweight and durable, they are designed for fast assembly and transport, making them ideal for businesses that need professional signage on the go.

- Lightweight and compact for easy transport and storage
- Quick and simple assembly for fast deployment at events or retail environments
- Foldable design allows effortless packing into the included carry bag

Part #	Size (WxH)	Description	Price
XB3272	31.5 x 72"	Large X-Banner Stand with Banner and Carry Bag	\$198.95
BV3272	31.5 x 72"	Large Replacement Banner with 4 Grommets Only	\$133.50
XB2463	24 x 63"	Small X-Banner Stand with Banner and Carry Bag	\$169.95
BV2463	24 x 63"	Small Replacement Banner with 4 Grommets Only	\$110.10

X-Banner

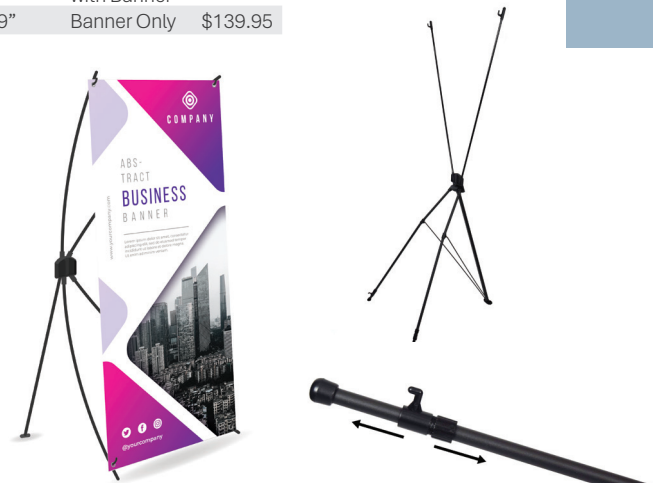

Banner Stands



BANNERS - FULL COLOUR

Great for announcing special sales, grand openings, hours of operation, retail displays, tradeshow, branding, and seminars.

- 13 oz. and 18 oz. heavy duty indoor/outdoor material
- Brilliant colours and sharpness - grommets included.
- Add hemming for added strength and durability to the edges, prevent fraying
- 22", 34", and 46" width available

Standard - 13oz. Banners

Indoor or outdoor use. If being used outdoors ensure it's securely fastened against a flat wall using all grommets. Recommend 18oz for outdoor use over 50 sq/ft. If no hem or grommets are needed, specify at time of order.



22" Wide - 13oz. Banners

Size	Hem & Grommets		Grommets Only	
	Part #	Price	Part #	Price
22 x 36"	212B23	\$60.30	212B23NH	\$60.30
22 x 48"	212B24	\$72.20	212B24NH	\$72.20
22 x 60"	212B25	\$84.20	212B25NH	\$84.20
22 x 72"	212B26	\$100.10	212B26NH	\$100.10
22 x 84"	212B27	\$112.30	212B27NH	\$112.30
22 x 96"	212B28	\$122.75	212B28NH	\$122.75
22 x 120"	212B210	\$151.85	212B210NH	\$151.85
22 x 144"	212B212	\$171.15	212B212NH	\$171.15

34" Wide - 13oz. Banners

Size	Hem & Grommets		Grommets Only	
	Part #	Price	Part #	Price
34 x 36"	212B33	\$75.85	212B33NH	\$75.85
34 x 48"	212B34	\$94.55	212B34NH	\$94.55
34 x 60"	212B35	\$118.10	212B35NH	\$118.10
34 x 72"	212B36	\$133.50	212B36NH	\$133.50
34 x 84"	212B37	\$146.00	212B37NH	\$146.00
34 x 96"	212B38	\$149.75	212B38NH	\$149.75
34 x 120"	212B310	\$187.20	212B310NH	\$187.20
34 x 144"	212B312	\$208.60	212B312NH	\$208.60

46" Wide - 13oz. Banners

Size	Hem & Grommets		Grommets Only	
	Part #	Price	Part #	Price
46 x 48"	212B44	\$125.85	212B44NH	\$125.85
46 x 60"	212B45	\$148.40	212B45NH	\$148.40
46 x 72"	212B46	\$166.90	212B46NH	\$166.90
46 x 84"	212B47	\$181.85	212B47NH	\$181.85
46 x 96"	212B48	\$199.95	212B48NH	\$199.95
46 x 120"	212B410	\$249.70	212B410NH	\$249.70
46 x 144"	212B412	\$278.15	212B412NH	\$278.15

13oz. Custom Banner Sizes - Exceeding Other Charts

If custom sq/ft falls within the standard grids, then round up to the closest size. Ex: custom size of 34 x 90" rounds up to Part #212B38. For sizes greater than the standard grids, use custom pricing below.

Width	Sq/ft	Hem & Grommets		Grommets Only	
		Part #	\$ Sq/ft	Part #	\$ Sq/ft
22"	25-48	212B	\$7.15	212BNH	\$7.15
34"	37-48	212B	\$5.80	212BNH	\$5.80
ALL	49-99	212B	\$5.75	212BNH	\$5.75
ALL	100-250	212B	\$5.65	212BNH	\$5.65



13oz smooth banner with grommets and no hemmed edges

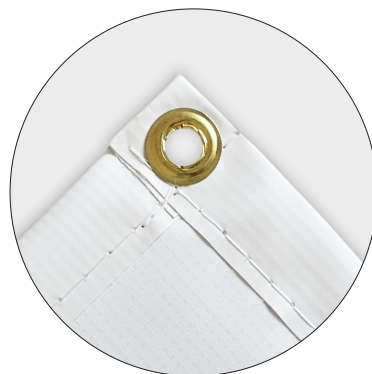

13oz scrim banner with grommets and hemmed edges for extra strength and durability

Heavy Duty – 18oz. Banners

Indoor or outdoor use hung anyway desired using the grommets.



22" Wide - 18oz. Banners

Size	Hem & Grommets		Grommets Only	
	Part #	Price	Part #	Price
22 x 36"	222B23	\$82.00	222B23NH	\$68.75
22 x 48"	222B24	\$98.20	222B24NH	\$84.05
22 x 60"	222B25	\$113.40	222B25NH	\$98.40
22 x 72"	222B26	\$128.35	222B26NH	\$112.55
22 x 84"	222B27	\$140.15	222B27NH	\$123.45
22 x 96"	222B28	\$143.65	222B28NH	\$126.10
22 x 120"	222B210	\$173.30	222B210NH	\$154.05
22 x 144"	222B212	\$196.85	222B222NH	\$175.85

46" Wide - 18oz. Banners

Size	Hem & Grommets		Grommets Only	
	Part #	Price	Part #	Price
46 x 48"	222B44	\$149.55	222B44NH	\$132.00
46 x 60"	222B45	\$169.80	222B45NH	\$150.50
46 x 72"	222B46	\$192.55	222B46NH	\$171.60
46 x 84"	222B47	\$211.85	222B47NH	\$189.15
46 x 96"	222B48	\$234.20	222B48NH	\$209.80
46 x 120"	222B410	\$292.50	222B410NH	\$255.55
46 x 144"	222B412	\$329.55	222B412NH	\$293.15

34" Wide - 18oz. Banners

Size	Hem & Grommets		Grommets Only	
	Part #	Price	Part #	Price
34 x 36"	222B33	\$99.45	222B33NH	\$84.90
34 x 48"	222B34	\$121.30	222B34NH	\$105.45
34 x 60"	222B35	\$141.85	222B35NH	\$124.75
34 x 72"	222B36	\$154.05	222B36NH	\$135.65
34 x 84"	222B37	\$168.50	222B37NH	\$148.80
34 x 96"	222B38	\$175.45	222B38NH	\$154.45
34 x 120"	222B310	\$219.30	222B310NH	\$188.60
34 x 144"	222B312	\$247.15	222B312NH	\$221.00

18oz. Custom Banner Sizes - Exceeding Other Charts

If custom sq/ft falls within the standard grids, then round up to the closest size. Ex: custom size of 22 x 90" rounds up to Part #222B28. For sizes greater than the standard grids, use custom pricing below.

Width	Sq/ft	Hem & Grommets		Grommets Only	
		Part #	\$ Sq/ft	Part #	\$ Sq/ft
22"	25-48	222B	\$8.20	222BNH	\$7.30
34"	37-48	222B	\$6.85	222BNH	\$6.10
ALL	49-99	222B	\$6.80	222BNH	\$6.05
ALL	100-250	222B	\$6.70	222BNH	\$6.00

Mesh – 8oz. Banners

Mesh banners are similar to vinyl banners, but they use a mesh pattern that allows wind to pass through. They are typically hung on chain-linked fences but can be displayed in a number of different settings. They can be hung using grommets or pole pockets.

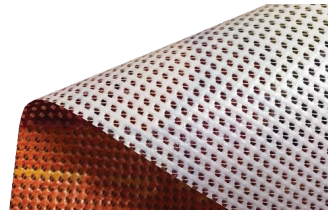

22" Wide - 8oz. Mesh Banners

Size	Hem & Grommets		Grommets Only	
	Part #	Price	Part #	Price
22 x 36"	232B23	\$71.20	232B23NH	\$64.55
22 x 48"	232B24	\$85.20	232B24NH	\$78.15
22 x 60"	232B25	\$98.80	232B25NH	\$91.30
22 x 72"	232B26	\$114.25	232B26NH	\$106.30
22 x 84"	232B27	\$126.25	232B27NH	\$117.90
22 x 96"	232B28	\$133.25	232B28NH	\$124.40
22 x 120"	232B210	\$162.60	232B210NH	\$153.00
22 x 144"	232B212	\$184.00	232B232NH	\$173.50

46" Wide - 8oz. Mesh Banners

Size	Hem & Grommets		Grommets Only	
	Part #	Price	Part #	Price
46 x 48"	232B44	\$137.75	232B44NH	\$128.90
46 x 60"	232B45	\$159.10	232B45NH	\$149.45
46 x 72"	232B46	\$179.75	232B46NH	\$169.25
46 x 84"	232B47	\$196.85	232B47NH	\$185.50
46 x 96"	232B48	\$217.05	232B48NH	\$204.85
46 x 120"	232B410	\$271.10	232B410NH	\$252.60
46 x 144"	232B412	\$303.85	232B412NH	\$285.65

34" Wide - 8oz. Mesh Banners

Size	Hem & Grommets		Grommets Only	
	Part #	Price	Part #	Price
34 x 36"	232B33	\$87.65	232B33NH	\$80.35
34 x 48"	232B34	\$107.95	232B34NH	\$100.00
34 x 60"	232B35	\$129.95	232B35NH	\$121.40
34 x 72"	232B36	\$143.75	232B36NH	\$134.55
34 x 84"	232B37	\$157.25	232B37NH	\$147.40
34 x 96"	232B38	\$162.60	232B38NH	\$152.10
34 x 120"	232B310	\$203.25	232B310NH	\$187.90
34 x 144"	232B312	\$227.90	232B312NH	\$214.80

8oz. Mesh Custom Banner Sizes - Exceeding Other Charts

If custom sq/ft falls within the standard grids, then round up to the closest size. Ex: custom size of 22 x 90" rounds up to Part #232B28. For sizes greater than the standard grids, use custom pricing below.

Width	Sq/ft	Hem & Grommets		Grommets Only	
		Part #	\$ Sq/ft	Part #	\$ Sq/ft
22"	25-48	232B	\$7.65	232BNH	\$7.25
34"	37-48	232B	\$6.40	232BNH	\$5.95
ALL	49-99	232B	\$6.20	232BNH	\$5.90
ALL	100-250	232B	\$6.10	232BNH	\$5.85



NEW

Feather Flags

Their tall, vertical design makes them a go-to choice for storefronts, events, and roadside promotions. With the opacity of our block-out material, double sided options can display two completely different images on each side.

Single Sided

Part #	Description	1-9
6SSFFST	6' Flag Ground Stand	\$236.95
6SSFFSL	6' Flag Ground Sleeve	\$236.95
8SSFFST	8' Flag Ground Stand	\$296.25
8SSFFSL	8' Flag Ground Sleeve	\$296.25
10SSFFST	10' Flag Ground Stand	\$329.95
10SSFFSL	10' Flag Ground Sleeve	\$329.95
12SSFFST	12' Flag Ground Stand	\$368.25
12SSFFSL	12' Flag Ground Sleeve	\$368.25

Double Sided

Part #	Description	1-9
6DSFFST	6' Flag Ground Stand	\$332.95
6DSFFSL	6' Flag Ground Sleeve	\$332.95
8DSFFST	8' Flag Ground Stand	\$419.95
8DSFFSL	8' Flag Ground Sleeve	\$419.95
10DSFFST	10' Flag Ground Stand	\$475.95
10DSFFSL	10' Flag Ground Sleeve	\$475.95
12DSFFST	12' Flag Ground Stand	\$563.95
12DSFFSL	12' Flag Ground Sleeve	\$563.95



NEW

Teardrop Flags

Teardrop flags are especially effective for logos or graphics that are nearly as tall as they are wide, due to the advertising area being different to the feather style flag. With the opacity of our block-out material, double sided options can display two completely different images on each side.

Single Sided

Part #	Description	1-9
5SSTFST	5' Flag Ground Stand	\$236.95
5SSTFSL	5' Flag Ground Sleeve	\$236.95
7SSTFST	7' Flag Ground Stand	\$296.25
7SSTFSL	7' Flag Ground Sleeve	\$296.25
9SSTFST	9' Flag Ground Stand	\$329.95
9SSTFSL	9' Flag Ground Sleeve	\$329.95
10SSTFST	10' Flag Ground Stand	\$368.25
10SSTFSL	10' Flag Ground Sleeve	\$368.25

Double Sided

Part #	Description	1-9
5DSTFST	5' Flag Ground Stand	\$332.95
5DSTFSL	5' Flag Ground Sleeve	\$332.95
7DSTFST	7' Flag Ground Stand	\$419.95
7DSTFSL	7' Flag Ground Sleeve	\$419.95
9DSTFST	9' Flag Ground Stand	\$475.95
9DSTFSL	9' Flag Ground Sleeve	\$475.95
10DSTFST	10' Flag Ground Stand	\$563.95
10DSTFSL	10' Flag Ground Sleeve	\$563.95

Flag Hardware

All poles are built from heavy-duty fiberglass, with an aluminium jacket reinforcing the base for added strength. The top section is both strong and flexible, designed to keep your banner secure while bending with the elements rather than breaking.

The ground sleeve system is one of the most reliable in the industry. Installed at ground level, the sleeve allows the pole to be easily removed for lawn care while the sleeve stays in place. It can be installed or relocated as needed, and setup is simple—the flag slides over the pole and is secured to the adaptor with a small bungee cord.

For concrete, asphalt, or indoor use, the stand is the ideal solution. It offers the same easy setup but with greater flexibility, making it perfect for anyone who needs a portable, non-permanent option.

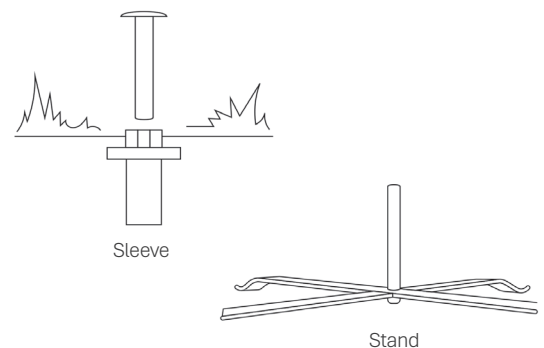

Quantity Discounts			
5%	10%	15%	20%
10-24	25-49	50-99	100+

TABLE TOP SIGNS AND HANGING BANNERS

Bright, bold, and built to last. Our full-colour signs and banners are durable and designed to make your business stand out whether on display tables or hanging overhead.

NEW

Acrylic Table Top Signs

Durable 1/8" clear acrylic with a sleek 2" bend at the base. Printed in full colour with isolated white for sharp, vibrant results. Minimum order of 3.

Part#	Size	3-9	10-24	25-49	50-99	100-199	200+
ATTS46	4" x 6"	\$20.49	\$16.32	\$14.28	\$12.24	\$11.22	\$10.20
ATTS43	4" x 3"	\$13.20	\$10.56	\$9.24	\$7.92	\$7.26	\$6.60



Acrylic



Styrene

NEW

Styrene Table Top Signs

Lightweight 0.060" white styrene with a 2" bend at the base. Features full-colour digital printing for bold, eye-catching displays. Minimum order of 3.

Part#	Size	3-9	10-24	25-49	50-99	100-199	200+
STTS46	4" x 6"	\$15.84	\$12.67	\$11.09	\$9.50	\$8.71	\$7.92
STTS43	4" x 3"	\$10.25	\$8.20	\$7.18	\$6.15	\$5.64	\$5.13

Indoor Hanging Banners

13oz. super smooth banner material for brilliant colours and sharpness. Meant to be hung indoors only. The banners can be easily changed out for a fresh message. Banners with rails come with clear rails top and bottom as well as 2 banner clips, suction cups are sold separately.

Size	Description	Banner with Rails Part #	Banner with Rails Price	Banner Only Part #	Banner Only Price
12 x 18"	portrait	HB1218	\$41.60	HB1218R	\$29.95
18 x 24"	portrait	HB1824	\$52.50	HB1824R	\$40.65
24 x 36"	portrait	HB2436	\$68.65	HB2436R	\$56.00
36 x 24"	landscape	HB3624	\$82.80	HB2436R	\$56.00
24 x 48"	portrait	HB2448	\$77.55	HB2448R	\$64.70
48 x 24"	landscape	HB4824	\$91.65	HB2448R	\$64.70
12 x 18"	portrait - double sided	HB1218DS	\$56.15	HB1218DSR	\$37.40
18 x 24"	portrait - double sided	HB1824DS	\$70.90	HB1824DSR	\$50.80
24 x 36"	portrait - double sided	HB2436DS	\$94.75	HB2436DSR	\$70.00
36 x 24"	landscape - double sided	HB3624DS	\$109.10	HB2436DSR	\$70.00
24 x 48"	portrait - double sided	HB2448DS	\$108.80	HB2448DSR	\$80.85
48 x 24"	landscape - double sided	HB4824DS	\$122.90	HB2448DSR	\$80.85
HBM	Custom indoor hanging banner - please call				
HBMR	Custom indoor hanging banner - please call				

Accessories for Indoor Hanging Banners

Part #	Description	Price
BRCP	2 Banner clips that slide into rail	\$1.30
SC150P	2 suction cups 1.75" dia. with hooks	\$2.60



Quantity Discounts				
10%	20%	30%	40%	50%
3-5	6-10	11-29	30-49	50+



Hanging Banner & Table Top

TROPHIES & 3D LETTERING & PLAQUES

The full line of Gemini lettering is available for every application. The colours and choices are endless.

Metal Plaques

- Cast & Architectural or Etched & Engraved
- Incredible variety and breathtaking detail
- Add prestige to any building or development
- Create a plaque for a retirement, winning an award, memorialize a loved one, or commemorate a historic place
- Available in aluminum, bronze, brass, copper
- Designs in any shape

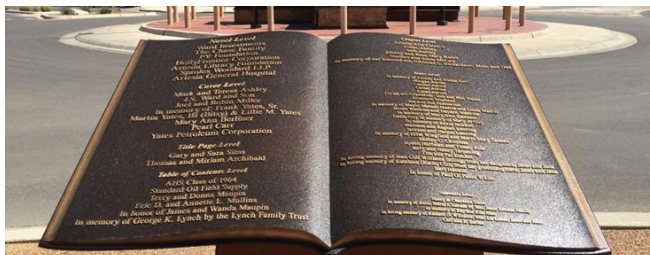

1/8 non-glare acrylic on maple

1/4 clear acrylic on walnut

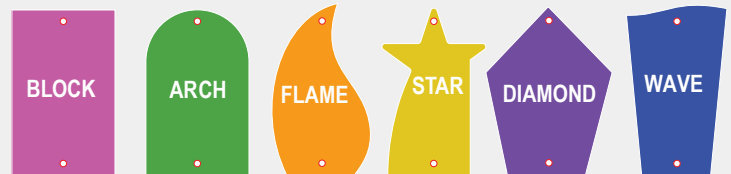

Acrylic on Wood Trophies

D

- Unique, high-quality trophy
- Ability to print full colour images
- Available in 1/4" clear acrylic or 1/8" non-glare acrylic
- Acrylic is mounted onto wood panel using stainless steel standoffs
- Variety of custom shapes available
- Choice of either maple or walnut wood backers

Part#	Size	1-9	10-24	25-49	50-99
LEA	5" x 8"	\$106.75	\$101.41	\$96.08	\$90.74

Plastic Letters & Logos

- Laser Cut Acrylic or Formed Plastic
- Lifetime Guarantee (labour and installation not included)
- Over 30 standard colours and virtually any style is possible

Metal Letters & Logos

- Flat Cut Metal or Cast Metal
- Available in aluminum, bronze, brass, copper, or steel
- Durable, long lasting beauty
- Numerous metal finishes give you the choice of dazzling shine, brilliant colour, or natural and antiqued metal



CUSTOM DRY ERASE BOARDS

Dry-Erase Whiteboards on Dibond Aluminum

Completely customizable print in full colour! Made from 1/8" white dibond (aluminum outer and polyethylene core). Easy to clean, extremely lightweight, rigid, and durable. Recommended for indoor use only. Mounting hardware (screws, stand-offs, or adhesive) and dry-erase markers sold separately.

Size	Part #	Description	Price	Part #	Description	Price
12 x 18"	DW1218A	Adhesive Back	\$65.55	DW1218S	5/8" Stand-offs (Set of 4)	\$103.65
18 x 24"	DW1824A	Adhesive Back	\$101.65	DW1824S	5/8" Stand-offs (Set of 4)	\$137.50
24 x 24"	DW2424A	Adhesive Back	\$126.65	DW2424S	5/8" Stand-offs (Set of 4)	\$160.25
24 x 36"	DW2436A	Adhesive Back	\$159.10	DW2436S	5/8" Stand-offs (Set of 4)	\$210.95
32 x 48"	DW3248	With Holes	\$190.65			

Custom Misc. Whiteboard - 1/8" Dibond (part #: DW)

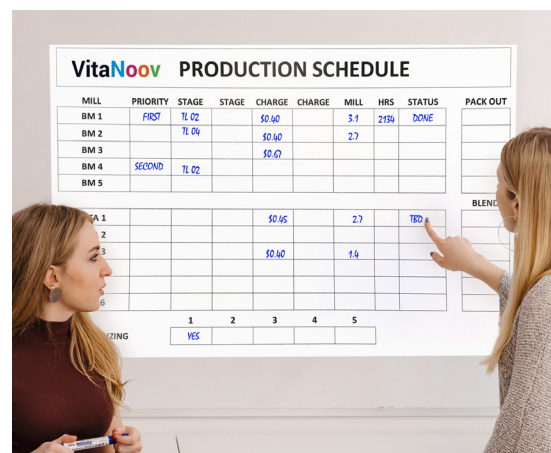

Satin Stainless Steel Standoffs

Mount your sign off the wall to give it that extra pop. 5/8" diameters standoffs shown and includes all mounting hardware. Holds material 1/8" to 1/4" thick.

Modern Acrylic Dry-Erase Boards with Stainless Steel Standoffs

Print any design in full colour or just black! Completely customizable. Made from 1/8" clear acrylic with graphics printed subsurface to protect them. Stand-offs included. Dry-erase markers sold separately. Recommended for indoor use only. For full description of white ink, see page 36.



A. Full Colour on White Acrylic

Graphics printed on acrylic backed in white.

Part #	Size	Description	Price
DA1218A	12 x 18"	Adhesive Back	\$62.25
DA1824A	18 x 24"	Adhesive Back	\$96.55
DA2424A	24 x 24"	Adhesive Back	\$118.70
DA2436A	24 x 36"	Adhesive Back	\$148.80
DA1212S	12 x 12"	5/8" Stand-offs (Set of 4)	\$85.35
DA1218S	12 x 18"	5/8" Stand-offs (Set of 4)	\$100.35
DA1224S	12 x 24"	5/8" Stand-offs (Set of 4)	\$111.00
DA1824S	18 x 24"	5/8" Stand-offs (Set of 4)	\$132.40
DA2424S	24 x 24"	5/8" Stand-offs (Set of 4)	\$152.30
DA2228S	22 x 28"	5/8" Stand-offs (Set of 4)	\$156.95
DA2436S	24 x 36"	5/8" Stand-offs (Set of 6)	\$200.70
DA3636S	36 x 36"	5/8" Stand-offs (Set of 8)	\$307.15
DA3648S	36 x 48"	5/8" Stand-offs (Set of 8)	\$328.00
DA4848S	48 x 48"	5/8" Stand-offs (Set of 8)	\$335.40

B. Black Ink Only Clear Acrylic Whiteboards

Graphics printed in black ink on clear acrylic with no white ink. No white backing.

Part #	Size	Description	Price
DA1218BS	12 x 18"	5/8" Stand-offs (Set of 4)	\$100.35
DA1824BS	18 x 24"	5/8" Stand-offs (Set of 4)	\$132.40
DA2424BS	24 x 24"	5/8" Stand-offs (Set of 4)	\$152.30
DA2436BS	24 x 36"	5/8" Stand-offs (Set of 6)	\$200.70

C. Full Colour Clear Acrylic With Isolated White

Graphics printed in full colour on clear acrylic with isolated white ink. For full description of isolated white ink, see page 36.

Part #	Size	Description	Price
DA1218WS	12 x 18"	5/8" Stand-offs (Set of 4)	\$108.50
DA1824WS	18 x 24"	5/8" Stand-offs (Set of 4)	\$143.35
DA2424WS	24 x 24"	5/8" Stand-offs (Set of 4)	\$165.10
DA2436WS	24 x 36"	5/8" Stand-offs (Set of 6)	\$217.30

D. Magnetic Dry-Erase Boards

Print any design you'd like in full colour. Completely customizable. Made from 30 mil thick magnet. Recommended for indoor use only.

Part #	Size	Price
MS1218SW	12 x 18"	\$79.75
MS1824SW	18 x 24"	\$108.80

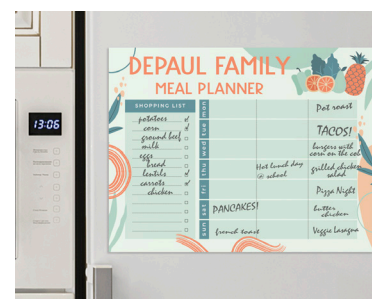

STENCILS

Multiple uses only limited by your imagination!

- Decorative or industrial stencils for parking lots, playgrounds, curbs, drums, pipes, shipping crate marking, and more!
- Clean stencils with solvent to reuse

Custom Laser Cut Stencils



Great for decorative designs. Available in Mylar, Styrene, or Magnetic. Max size for mylar and 60 mil Styrene is 48" x 96", 24" x 96" for 30 mil Magnetic, and 28" x 96" for Clear PETG.

Part #	Thickness	Material
218-1	10 mil	Mylar
218-2	30 mil	Magnetic
218-3	60 mil	Styrene (heavy duty)
218-4	12 mil	Clear Plastic PETG

Sq Ft	Mylar & Clear PETG	Magnetic	Styrene
<1 sqft	\$26.95	\$30.50	\$27.85
1	\$35.60	\$57.25	\$41.20
2	\$44.30	\$84.00	\$54.60
3	\$54.75	\$116.10	\$70.65
4	\$65.20	\$148.20	\$86.70
5	\$75.25	\$179.25	\$102.20
6	\$85.25	\$210.05	\$117.60
7	\$95.25	\$240.90	\$133.00
8	\$105.30	\$271.70	\$148.45
9	\$115.30	\$302.50	\$163.85
10	\$125.30	\$333.35	\$179.25
11-14*	\$11.80*	\$31.60*	\$17.15*
15-19*	\$11.25*	\$31.05*	\$16.60*
20-25*	\$10.70*	\$30.50*	\$16.05*
26-32*	\$10.20*	\$30.00*	\$15.55*

Quantity Discounts			
10%	20%	25%	30%
10-24	25-49	50-99	100+

TYPESTYLES

OLDE SCRIPT STENCIL
LE POCHOIR TOP SECRET*
MAVERICK* LINTNEC*
MUTE FRUIT Stencilia-A*
ODESSA Stencil Gothic*
Dina* DIN SCHABLON

*Available in upper and lower case



*\$/sqft - determined by measuring edge to edge of image. For larger sizes, please contact us for a custom quotation. Add \$15 for any font used other than our standard fonts. Add \$20 for each logo.

ALUMINUM SIGNAGE

Available in reflective or non-reflective. Order one of our popular stock signs or customize your own sign. Visit our website for more designs.

Aluminum Parking Signs - Stock Message

Many more stock signs! For a complete list, visit our website.

Part #	Description	Size (WxHxD)	Price
212-P	Non Reflective	12 x 18" x .051"	\$54.95
212-PR	Reflective	12 x 18" x .064"	\$73.65
212-P2	Non Reflective	18 x 24" x .051"	\$75.75

Aluminum Parking Signs - Custom Message

Create your own sign with your own graphics!

Part #	Description	Size (WxHxD)	Price
212-C	Non Reflective	12 x 18" x .051"	\$68.95
212-CR	Reflective	12 x 18" x .064"	\$83.75
212-C2	Non Reflective	18 x 24" x .051"	\$99.95
212-CR2	Reflective	18 x 24" x .064"	\$114.95
212-C3	Non Reflective	24 x 24" x .064"	\$133.25

Steel Posts



Part #	Description	Price
212SP8	8' mini square post (no hardware)	\$76.75
212SP	10' U channel post (hardware included)	\$111.55
212SP12	12' U channel post for bylaw enforced parking signage (hardware included)	\$135.10
212H	U channel hardware: 2 u-clips, 2 nuts, 2 bolts, 2 washers	\$12.60



Brass Interlocking Stencils

Stencils can be moved around to create a personalized message.

Char. Height (in.)	Alphabetical Set (26 letters)	Numerical Set (0-9)		
Height	Part #	Price	Part #	Price
1/2"	2001C	\$110.25	2000C	\$65.35
3/4"	2011C*	\$110.25	2010C*	\$65.35
1"	2021C	\$110.25	2020C	\$65.35
1-1/2"	2041C*	\$115.65	2040C*	\$68.55
2"	2061C	\$115.65	2060C	\$68.55
2-1/2"	2071C*	\$115.65	2070C*	\$68.55
3"	2081C	\$175.65	2080C	\$89.95
4"	2091C	\$253.25	2090C	\$132.75
5"	2101C	\$349.95	2100C	\$165.75
6"	2111C	\$384.85	2110C	\$185.95

*discontinued and will be sold while supplies last



Stock Shipping Stencils

Stock shipping stencils laser cut out of mylar. Available in 3 sizes: 6", 9", 12". Style # shown. More stock stencils are available.

Part #	Size	Price
SS66	6"	\$19.80
SS99	9"	\$23.50
SS1212	12"	\$29.20



P-94



P-9



P-36a



P-147



P-79



P-47



PRICE GUNS & UNIVERSAL LABELS

For everyday price marking, coding, and dating.

- All price guns sold as starter kit, including label gun with ink roll, 10 rolls of labels, and one replacement ink roll
- All 7 bands are bilingual \$00.00 or 00,00\$, and the 8 band dater is YYYYMMDD or DDMMYY



Choose the right one for your application!

All labels shown at actual size.

SM7K

22 x 12 mm labels

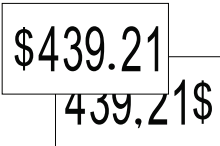

SM8K

22 x 12 mm labels

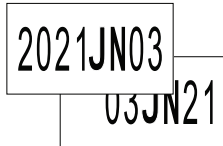

SM10+7K

26 x 16 mm labels



ZS+7K (with Slug)

26 x 12 mm labels



3 Stock slugs included!

SPECIAL SALE! VENTE

Part #	Description	Label Size	Price	10+ Price
SM7K	1 line, 7 band - Price Gun Kit	22x12 mm	\$89.95	\$71.95
SM8K	1 line, 8 band - Open Code Dater Kit	22x12 mm	\$89.95	\$71.95
SM10+7K	2 line, 10 band over 7 - Numbers and Price Kit	26x16 mm	\$99.95	\$79.95
	2 line, Slug over 7 band - kit.			
ZS+7K	Top line is an interchangeable slug that is 18 x 4 mm. Comes with 3 stock slugs: SPECIAL, SALE!, VENTE	26x12 mm	\$73.95	\$59.95

Accessories

Part #	Description	Price	10+ Price
ZCS	Custom slug for Printex ZS+7 (18 x 4 mm)	\$30.96	N/A
ZIR	Replacement ink roll for all Printex guns	\$9.40	\$7.61
SMIR	Replacement ink roll for all Smart guns	\$9.40	\$7.61



Interchangeable Slug for ZS+7K gun

- Create your own custom slug
- Use 1 price marker for multiple messages

Go to www.Sterling.ca/band-layouts.cfm to see band layouts!

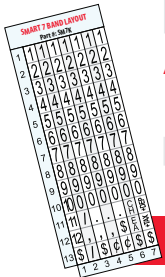

All Temperature Labels for Smart and Printex Price Guns

Made in Italy, special freezer grade adhesive is standard with these labels, giving you greater flexibility. Comes in a resealable clamshell with packs of 10-12 rolls and great quantity discounts.

22 x 12 mm All Temperature Labels

Part #	Description	Labels/roll	Rolls/pack	Total Labels	Price/pack	6 Packs Price/pack	12 Packs Price/pack	24 Packs Price/pack
SM2212W	White	1500	12	18,000	\$41.95	\$33.95	\$30.96	\$27.96
SM2212Y	Yellow	1500	12	18,000	\$41.95	\$33.95	\$30.96	\$27.96
SM2212-BB	Best Before*	1500	12	18,000	\$41.95	\$33.95	\$30.96	\$27.96

26 x 16 mm All Temperature Labels

Part #	Description	Labels/roll	Rolls/pack	Total Labels	Price/pack	6 Packs Price/pack	12 Packs Price/pack	24 Packs Price/pack
SM2616W	White	1000	10	10,000	\$41.95	\$33.95	\$30.96	\$27.96
SM2616Y	Yellow	1000	10	10,000	\$41.95	\$33.95	\$30.96	\$27.96
SM2616O	Orange	1000	10	10,000	\$41.95	\$33.95	\$30.96	\$27.96

26 x 12 mm All Temperature Labels

Part #	Description	Labels/roll	Rolls/pack	Total Labels	Price/pack	6 Packs Price/pack	12 Packs Price/pack	24 Packs Price/pack
SM2612W	White	1500	10	15,000	\$41.95	\$33.95	\$30.96	\$27.96
SM2612O	Orange	1500	10	15,000	\$41.95	\$33.95	\$30.96	\$27.96

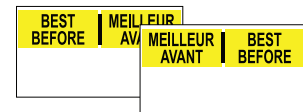

*Sample of pre-printed SM2212-BB with alternating message



-30° C to 80° C

All Temperature Labels

Permanent labels for all temperatures including freezing. To be applied at room temperature.



Distributed by:

markmaker®

Mark Maker is a registered trademark of Sterling Marking Products Inc.

www.markmaker.ca

SP02261ZA OCT25